



Is Now Part of



ON Semiconductor®

To learn more about ON Semiconductor, please visit our website at
www.onsemi.com

ON Semiconductor and the ON Semiconductor logo are trademarks of Semiconductor Components Industries, LLC dba ON Semiconductor or its subsidiaries in the United States and/or other countries. ON Semiconductor owns the rights to a number of patents, trademarks, copyrights, trade secrets, and other intellectual property. A listing of ON Semiconductor's product/patent coverage may be accessed at www.onsemi.com/site/pdf/Patent-Marking.pdf. ON Semiconductor reserves the right to make changes without further notice to any products herein. ON Semiconductor makes no warranty, representation or guarantee regarding the suitability of its products for any particular purpose, nor does ON Semiconductor assume any liability arising out of the application or use of any product or circuit, and specifically disclaims any and all liability, including without limitation special, consequential or incidental damages. Buyer is responsible for its products and applications using ON Semiconductor products, including compliance with all laws, regulations and safety requirements or standards, regardless of any support or applications information provided by ON Semiconductor. "Typical" parameters which may be provided in ON Semiconductor data sheets and/or specifications can and do vary in different applications and actual performance may vary over time. All operating parameters, including "Typicals" must be validated for each customer application by customer's technical experts. ON Semiconductor does not convey any license under its patent rights nor the rights of others. ON Semiconductor products are not designed, intended, or authorized for use as a critical component in life support systems or any FDA Class 3 medical devices or medical devices with a same or similar classification in a foreign jurisdiction or any devices intended for implantation in the human body. Should Buyer purchase or use ON Semiconductor products for any such unintended or unauthorized application, Buyer shall indemnify and hold ON Semiconductor and its officers, employees, subsidiaries, affiliates, and distributors harmless against all claims, costs, damages, and expenses, and reasonable attorney fees arising out of, directly or indirectly, any claim of personal injury or death associated with such unintended or unauthorized use, even if such claim alleges that ON Semiconductor was negligent regarding the design or manufacture of the part. ON Semiconductor is an Equal Opportunity/Affirmative Action Employer. This literature is subject to all applicable copyright laws and is not for resale in any manner.

User Guide for
FEBFAN7631_L17U120A

120 W LED Driver at Universal Line

Featured Fairchild Products:

FSL117MRIN

FL7930C

FAN7631

FAN73402

*Direct questions or comments
about this evaluation board to:
“Worldwide Direct Support”*

Fairchild Semiconductor.com

Table of Contents

1.	Introduction.....	3
1.1.	General Description of FSL117MIRN.....	3
1.2.	Features.....	4
1.3.	Internal Block Diagram.....	4
1.4.	General Description of FL7930C.....	5
1.5.	Features.....	5
1.6.	Internal Block Diagram.....	6
1.7.	General Description of FAN7631.....	6
1.8.	Features.....	7
1.9.	Internal Block Diagram.....	7
1.10.	General Description of FAN73402.....	8
1.11.	Features.....	8
1.12.	Internal Block Diagram.....	9
2.	Specifications for Evaluation Board.....	10
3.	Photographs.....	11
4.	Printed Circuit Board (PCB).....	12
5.	Schematic.....	13
6.	Bill of Materials.....	18
7.	Transformer Design.....	22
7.1.	Flyback Transformer (TS801).....	22
7.2.	PFC Inductor (LP801).....	23
7.3.	LLC Transformer (TM801).....	24
8.	Performance of Evaluation Board.....	25
8.1.	System Efficiency.....	25
8.2.	Power Factor and Total Harmonic Discharge (THD).....	27
8.3.	Constant-Current and voltage Regulation.....	28
8.4.	Overall Startup Performance.....	29
8.5.	Startup Performance in Flyback Stage.....	30
8.6.	Startup Performance in PFC stage.....	31
8.7.	Startup Performance in LLC Stage.....	32
8.8.	Key Waveforms for Input and Output.....	33
8.9.	Key Waveforms for Flyback Stage.....	34
8.10.	Key Waveforms for PFC Stage.....	35
8.11.	Key Waveforms for LLC Stage.....	37
8.12.	Key Waveforms for Single-Channel Boost Stage.....	39
8.13.	Dimming Performance.....	40
8.14.	LED Short/Open Protection at Multi CH Output.....	42
8.15.	Operating Temperature.....	43
9.	Revision History.....	44

This user guide supports the evaluation kit for the FSL117MRIN, FL7930C, FAN7631, and FAN73402; orderable as FEB-L017U120B. It should be used in conjunction with the product datasheets as well as Fairchild's application notes and technical support team. Please visit Fairchild's website at www.fairchildsemi.com.

1. Introduction

This document describes a proposed solution for a 120 W LED driver consisting of an AC-DC converter for flyback bias regulation, a boost converter for Power-Factor-Correction (PFC), an LLC resonant converter for a single LED channel with constant current and voltage or individual boost converters for two LED channels with constant current and dimming control. The input voltage range is $85 V_{RMS} - 300 V_{RMS}$ and there are DC outputs with a constant current of 2.4 A at $50 V_{MAX}$ for a single LED channel or with constant current and dimming of 1.2 V at 100 V for two LED channels.

The power supply mainly utilizes:

- FSL117MRIN – Green Mode Fairchild Power Switch (FPST™)
- FL7930B – CRM PFC Controller
- FAN7631 – Half-Bridge LLC Controller
- FAN73402 – Single-Channel Boost Controller (for each controller)
- FCPF190N60E and FCPF600N60Z – Fairchild SuperFET® Technology
- FDPF14N30 – Fairchild UniFET® Technology N-Channel MOSFET
- FFPF08H60S – Fairchild Hyperfast Rectifier
- MBR20200CT – Fairchild Schottky Rectifier
- RURD620CCS9A – Fairchild Ultra-Fast Recovery Rectifier (for discrete)

This document contains important information (e.g. schematic, bill of materials, printed circuit board layout, transformer design documentation), and the typical operating characteristics supporting this evaluation board.

1.1. General Description of FSL117MRIN

The FSL117MRIN is an integrated Pulse Width Modulation (PWM) controller and 700 V SenseFET specifically designed for offline Switched-Mode Power Supplies (SMPS) with minimal external components. The PWM controller includes an integrated fixed-frequency oscillator, Line Over-Voltage Protection (LOVP), Under-Voltage Lockout (UVLO), Leading-Edge Blanking (LEB), optimized gate driver, internal soft-start, temperature-compensated precise current sources for loop compensation, and self-protection circuitry. Compared with a discrete MOSFET and PWM controller solution, the FSL117MRIN can reduce total cost, component count, size, and weight; while simultaneously increasing efficiency, productivity, and system reliability. This device provides a basic platform for cost-effective design of a flyback converter.

1.2. General Description of FL7930C

The FL7930C is an active Power Factor Correction (PFC) controller for low- to high-power lumens applications that operate in Critical Conduction Mode (CRM). It uses a voltage-mode PWM that compares an internal ramp signal with the error amplifier output to generate a MOSFET turn-off signal. Because the voltage-mode CRM PFC controller does not need rectified AC line voltage information, it saves the power loss of an input voltage-sensing network. FL7930B provides over-voltage, open-feedback, over-current, input-voltage-absent detection, and under-voltage lockout protections. The FL7930B can be disabled if the INV pin voltage is lower than 0.45 V and the operating current decreases to a very low level. Using a new variable on-time control method, Total Harmonic Discharge (THD) is lower than conventional CRM boost PFC ICs. The FL7930C provides a PFC Ready pin that can be used to shutdown the boost power stage when PFC output voltage reaches the proper level (with hysteresis).

1.2.1. Features

- Additional PFC-Ready Function
- Input-Voltage-Absent-Detection Circuit
- Maximum Switching Frequency Limitation.
- Internal Soft-Start with Overshoot Prevention
- Internal Total harmonic Distortion (THD) Optimizer
- Precise Adjustable Output Over-Voltage Protection (OVP)
- Open-Feedback Protection and Disable Function
- Zero Current Detector (ZDC)
- 150 μ s Internal Startup Timer
- MOSFET Over-Current Protection (OCP)
- Under-Voltage Lockout with 3.5 V Hysteresis (UVLO)
- Low Startup (40 μ A) and Operating Current (1.5 mA)
- Totem-Pole Output with High State Clamp
- +500 / -800 mA Peak Gate Drive Current
- SOP-8 Package

1.2.2. Internal Block Diagram

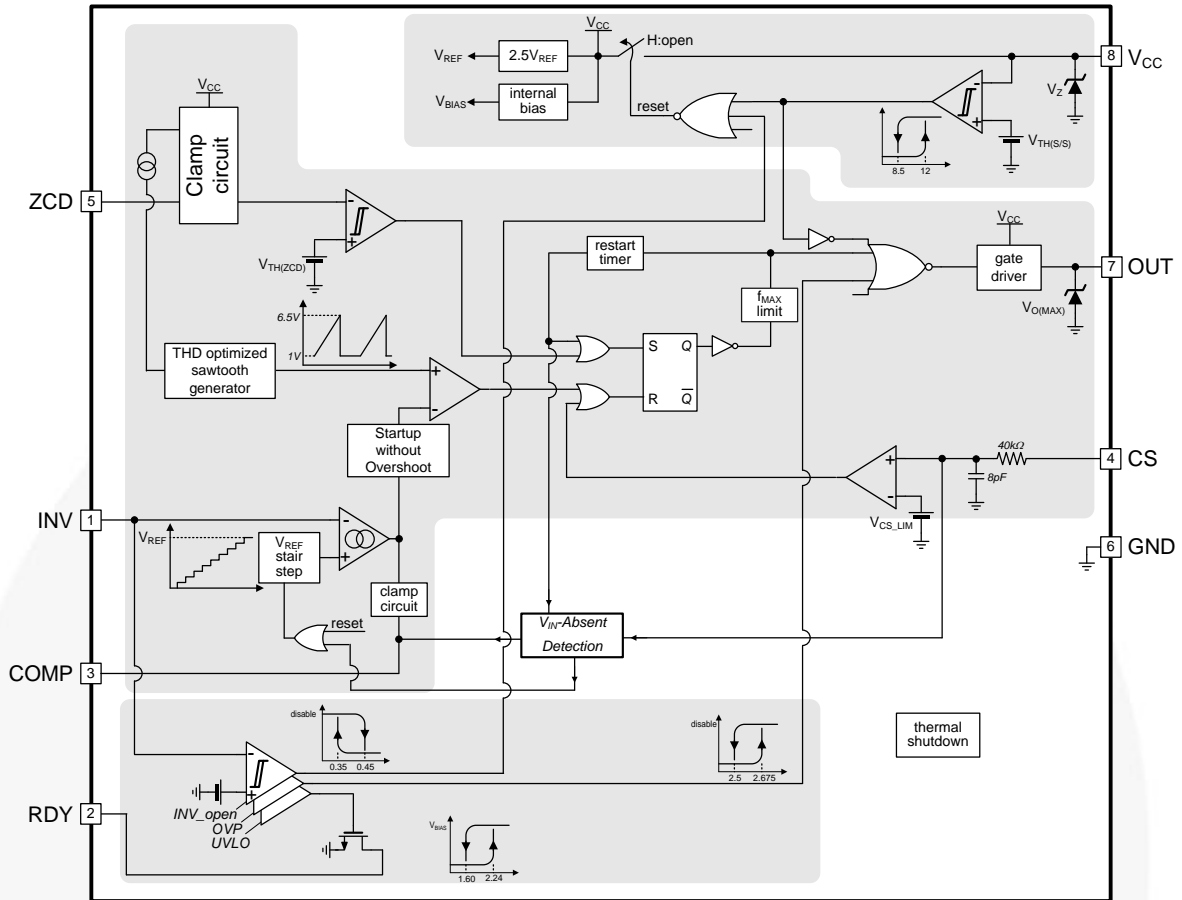

Figure 2. Block Diagram of FL7930C

1.3. General Description of FAN7631

The FAN7631 is a pulse-frequency modulation controller for high-efficiency half-bridge resonant converters that includes a high-side gate drive circuit, an accurate current-controlled oscillator, and various protection functions. The FAN7631 features include variable dead time, high operating frequency up to 600 kHz, protections such as LUVLO, and a selectable latch or A/R protection using the LS pin for user convenience. The Zero-Voltage-Switching (ZVS) technique reduces the switching losses and improves the efficiency significantly. ZVS also reduces the switching noise noticeably, which allows a small Electromagnetic Interference (EMI) filter. Offering everything necessary to build a reliable and robust resonant converter, the FAN7631 simplifies designs and improves productivity and performance. The FAN7631 can be applied to resonant converter topologies such as series resonant, parallel resonant, and LLC resonant converters.

1.3.1. Features

- Variable Frequency Control with 50% Duty Cycle for Half-bridge Resonant Converter Topologies
- High Efficiency through Zero-Voltage-Switching (ZVS)
- Up to 600 kHz Operating Frequency
- High Gate-Driving Current +500 mA/-1000 mA
- Precise Adjustable Output Over-Voltage Protection (OVP)
- Programmable Dead Time using a Resistor
- Pulse Skipping and Burst Operation for Frequency Limit (programmable) at Light-Load Condition
- Simple Remote on/off Control with Selectable Latch or A/R using FI or LS pin
- Protection Function; Over-Voltage Protection (OVP), Overload Protection (OLP), Over-Current Protection (OCP), Abnormal Over-Current Protection (AOCP), Internal Thermal Shutdown (TSD) and High Precise Line Under-Voltage Lockout (LUVLO)
- Level-Change OCP Function during Startup.
- SOP-16 Package

1.3.2. Internal Block Diagram

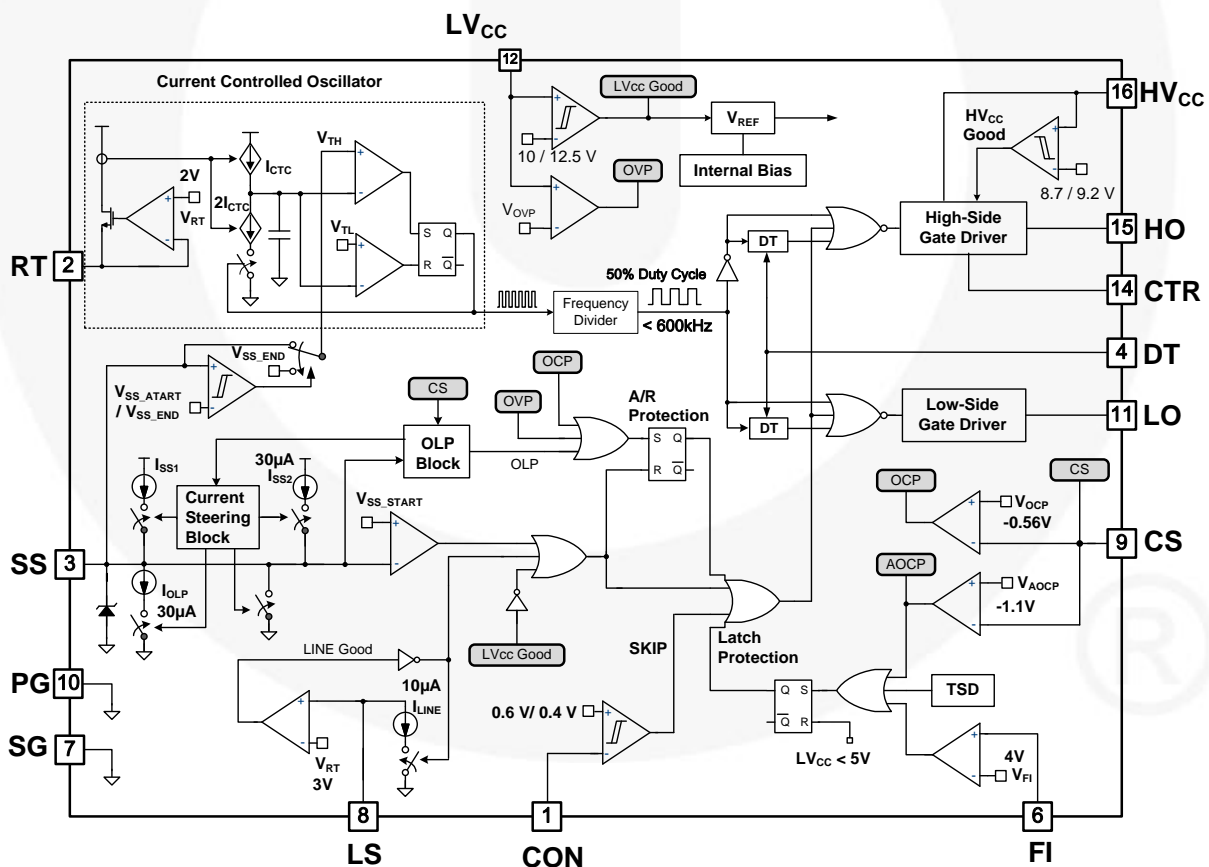

Figure 3. Block Diagram of FAN7631

1.4. General Description of FAN73402

The FAN73402 is a single-channel boost controller that integrates an N-channel power MOSFET for PWM dimming using Fairchild's proprietary planar Double-diffused MOSFET (DMOS) technology. The IC operates as a constant-current source for driving high-current LEDs. It uses Current Mode control with programmable slope compensation to prevent sub-harmonic oscillation. The IC provides protections including: open-LED protection, over-voltage protection, and direct-short protection for high system reliability. The IC internally generates a FAULT signal with delay if an abnormal LED string condition occurs. PWM dimming and analog dimming functions can be implemented independently. Internal soft-start prevents inrush current flowing into output capacitor at startup.

1.4.1. Features

- Single-Channel Boost LED Switch
- Internal Power MOSFET for PWM Dimming:
 $R_{DS(ON)}=1.0\ \Omega$ at $V_{GS}=10\ V$, $BV_{DSS}=200\ V$
- Current-Mode PWM Control
- Internal Programmable Slope Compensation
- Wide Supply Voltage Range: 10 V to 35 V
- LED Current Regulation: $\pm 1\%$
- Programmable Switching Frequency
- Analog and PWM Dimming
- Wide Dimming Ratio: On Time=10 μs to DC
- Cycle-by-Cycle Current Limiting
- Thermal Shutdown: 150°C
- Open-LED Protection (OLP)
- Over-Voltage Protection (OVP)
- Over-Current Protection (OCP)
- Error Flag Generation (for External Load Switch)
- Internal Soft-Start
- 16-Lead SOIC Package

1.4.2. Internal Block Diagram

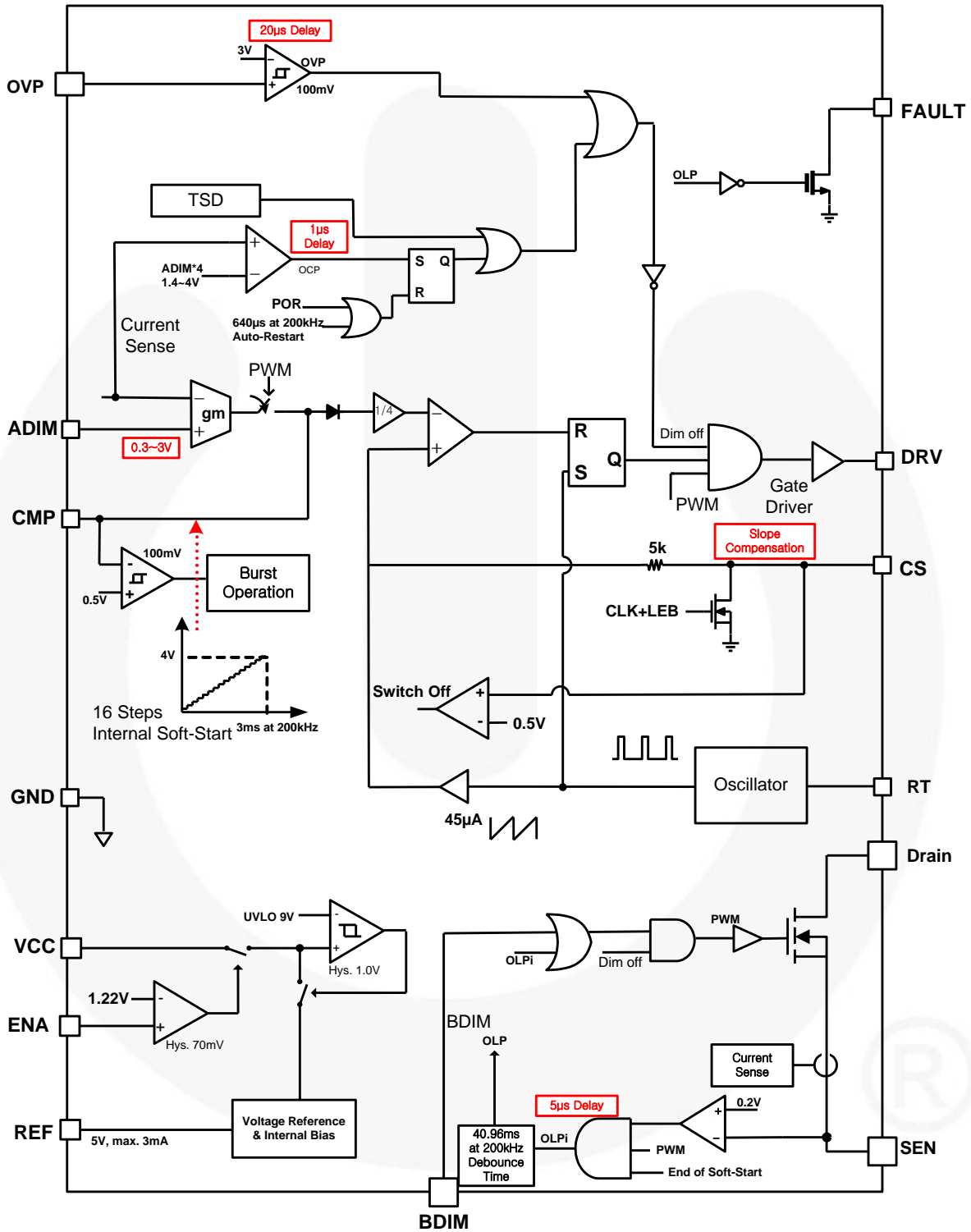

Figure 4. Block Diagram of FAN73402

2. Specifications for Evaluation Board

Table 1. Specifications for LED Lighting Lamp

Description		Symbol	Value	Comments
Input	Voltage	$V_{IN,MIN}$	85 V _{AC}	Minimum Input Voltage
		$V_{IN,MAX}$	300 V _{AC}	Maximum Input Voltage
		$V_{IN,NOMINAL}$	120 V/230 V	Nominal Input Voltage
	Frequency	f_{IN}	60 Hz/50 Hz	Line Frequency
Output	Voltage	V_{OUT_SINGLE}	50 V	Output Voltage for Single Channel LED
		V_{OUT_MULTI}	100 V	Output Voltage for Multi Channel LED
	Current	I_{OUT_SINGLE}	2.4 A	Output Current for Single Channel LED
		I_{OUT_MULTI}	1.2 A	Output Current for Multi Channel LED
Efficiency [Single Channel]		Eff_{85VAC}	87.77%	Efficiency at 85 V _{AC} Line Input Voltage
		Eff_{120VAC}	90.06%	Efficiency at 120 V _{AC} Line Input Voltage
		Eff_{140VAC}	90.86%	Efficiency at 140 V _{AC} Line Input Voltage
		Eff_{180VAC}	91.55%	Efficiency at 180 V _{AC} Line Input Voltage
		Eff_{230VAC}	91.99%	Efficiency at 230 V _{AC} Line Input Voltage
		Eff_{300VAC}	92.33%	Efficiency at 300 V _{AC} Line Input Voltage
Standby Power		P_{85VAC}	0.283 W	Standby Power at 85 V _{AC} Line Input Voltage
		P_{120VAC}	0.306 W	Standby Power at 120 V _{AC} Line Input Voltage
		P_{140VAC}	0.315 W	Standby Power at 140 V _{AC} Line Input Voltage
		P_{180VAC}	0.319 W	Standby Power at 180 V _{AC} Line Input Voltage
		P_{230VAC}	0.341 W	Standby Power at 230 V _{AC} Line Input Voltage
		P_{300VAC}	0.397 W	Standby Power at 300 V _{AC} Line Input Voltage
PF/THD		PF/THD_{85VAC}	0.998/4.58%	PF/THD at 85 V _{AC} Line Input Voltage
		PF/THD_{120VAC}	0.997/4.65%	PF/THD at 120 V _{AC} Line Input Voltage
		PF/THD_{140VAC}	0.995/4.74%	PF/THD at 140 V _{AC} Line Input Voltage
		PF/THD_{180VAC}	0.992/5.32%	PF/THD at 180 V _{AC} Line Input Voltage
		PF/THD_{230VAC}	0.980/7.89%	PF/THD at 230 V _{AC} Line Input Voltage
		PF/THD_{300VAC}	0.945/15.13%	PF/THD at 300 V _{AC} Line Input Voltage
Temperature	FSL117MRIN	$T_{FSL117MRIN}$	53.9°C	FSL117MRIN Temperature at 25°C
	FAN73402	$T_{FAN73402}$	82.1°C	FAN73402 Temperature at 25°C
	MOSFET	T_{PFC}	63.0°C	PFC MOSFET Temperature at 25°C
		T_{LLC}	59.2°C	LLC MOSFET Temperature at 25°C
		$T_{Boost_Channel}$	61.8°C	Boost Channel MOSFET Temperature at 25°C
		T_{LLC}	67.5°C	LLC Rectifier Temperature at 25°C
		$T_{Boost_Channel}$	69.5°C	Boost Channel Rectifier Temperature at 25°C
		T_{LLC}	72.6°C	LLC Transformer Temperature at 25°C

All data of the evaluation board measured with the board enclosed in a case and external temperature around 25°C.

3. Photographs

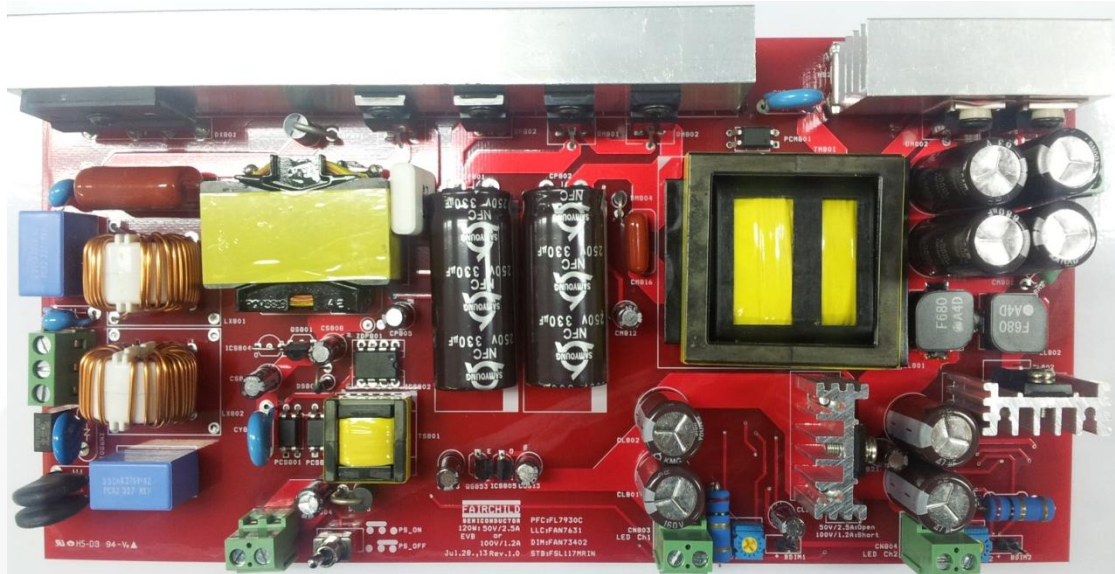

Figure 5. Top View [Dimensions: 232mm (L) x 114 mm (W) x 27 mm (H)]

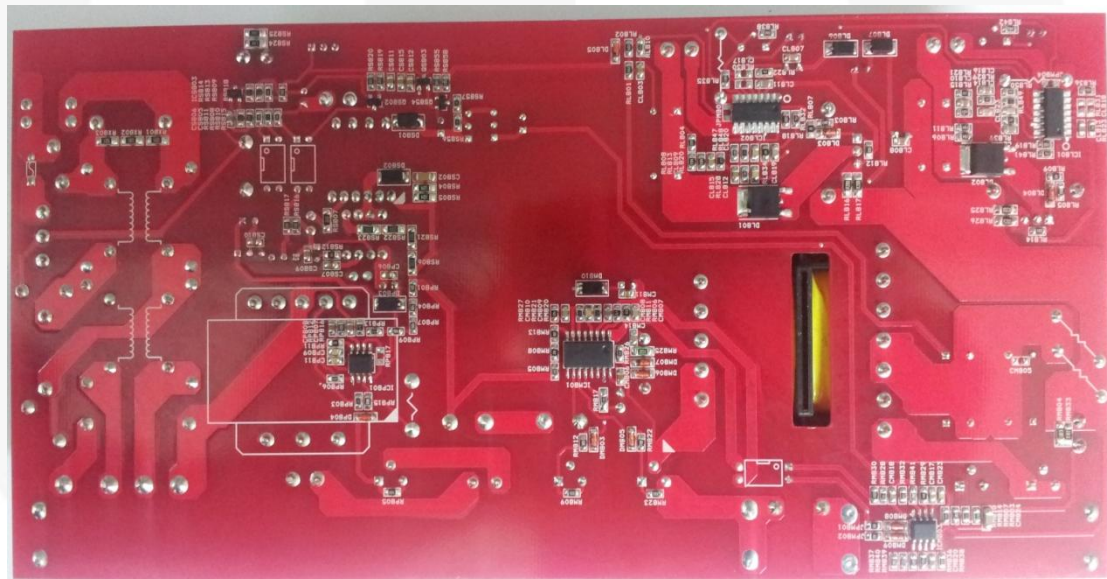

Figure 6. Bottom View [Dimensions: 232mm (L) x 114 mm (W) x 27 mm (H)]

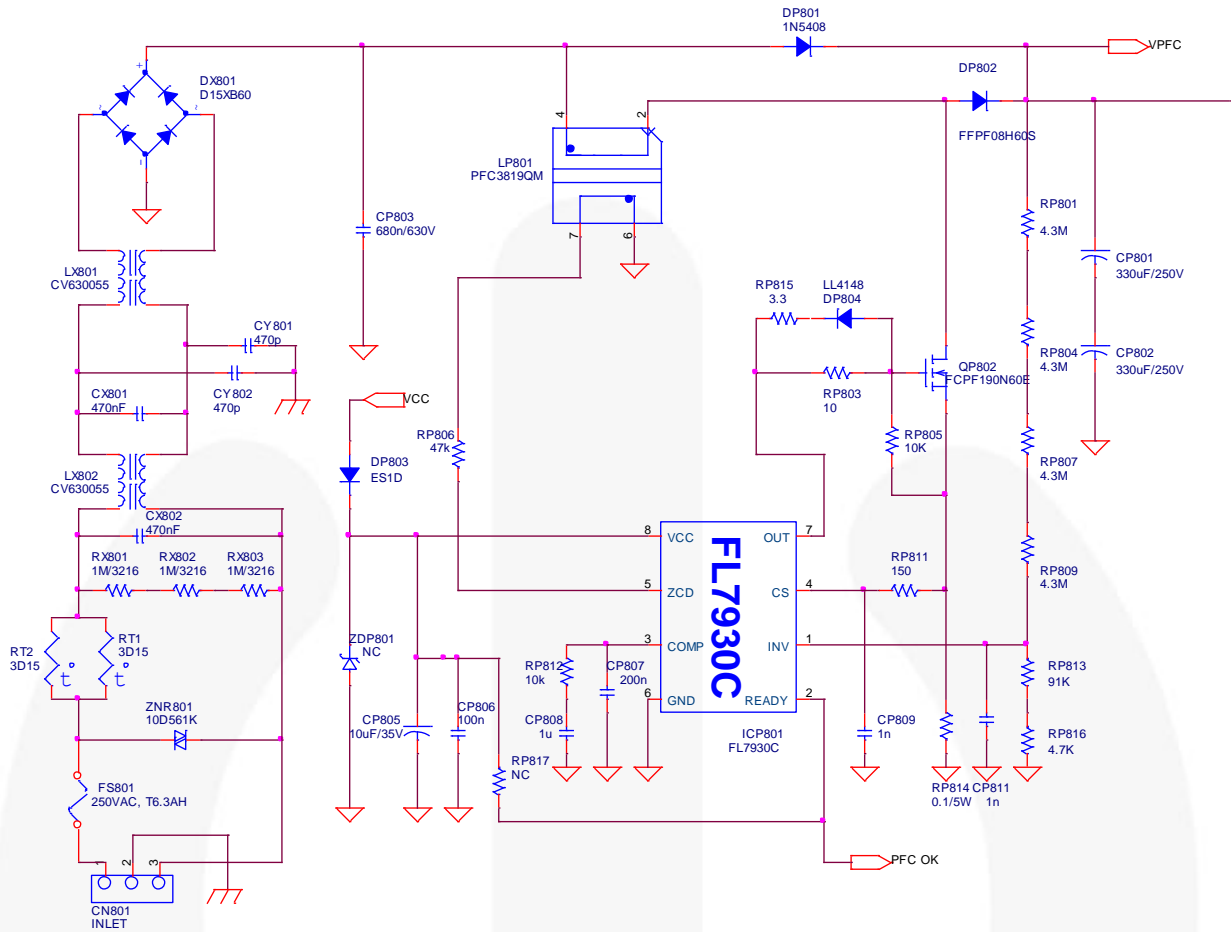

Figure 10. Schematic for PFC Part

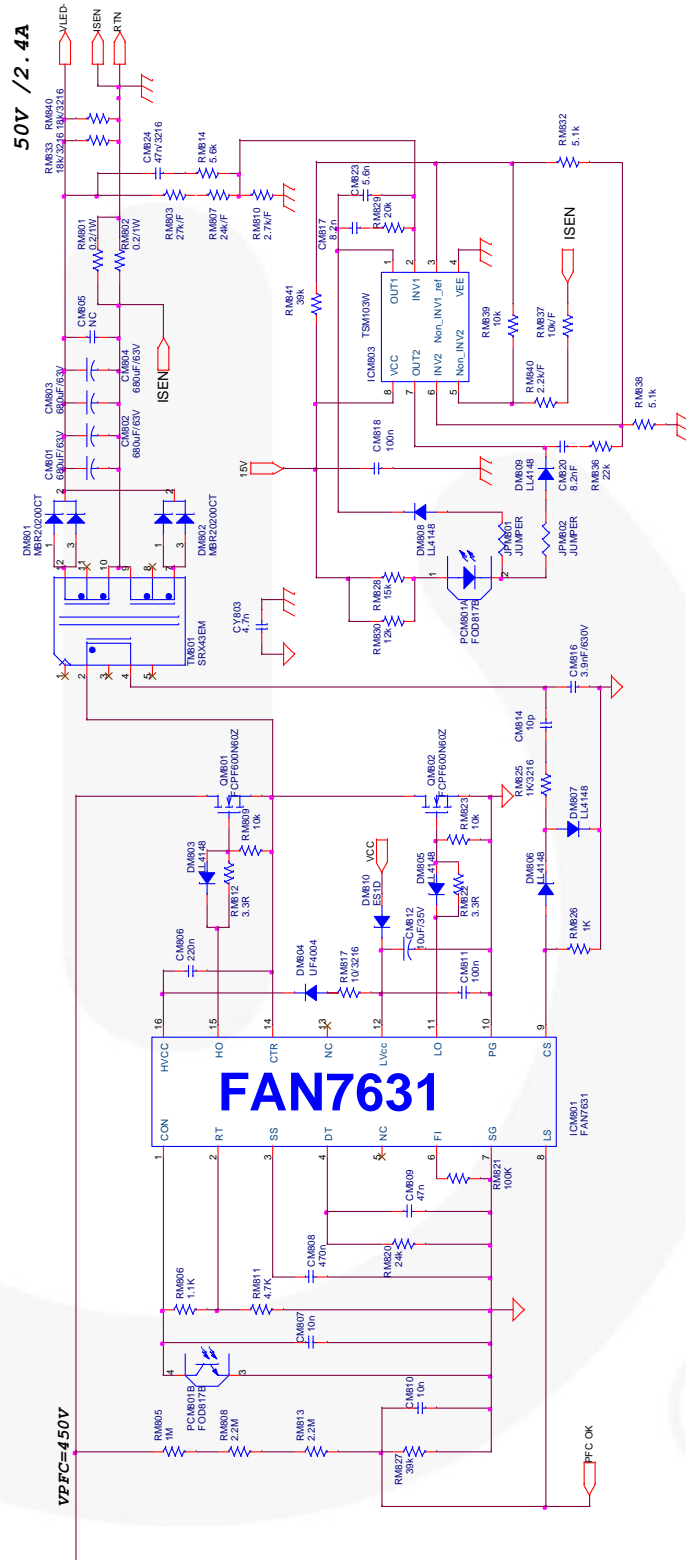

Figure 11. Schematic for LLC Part

⊗ RM830 should be NC in case of 50 V/2.4 A output and use 16 k value in case of 100 V/1.2 A output.

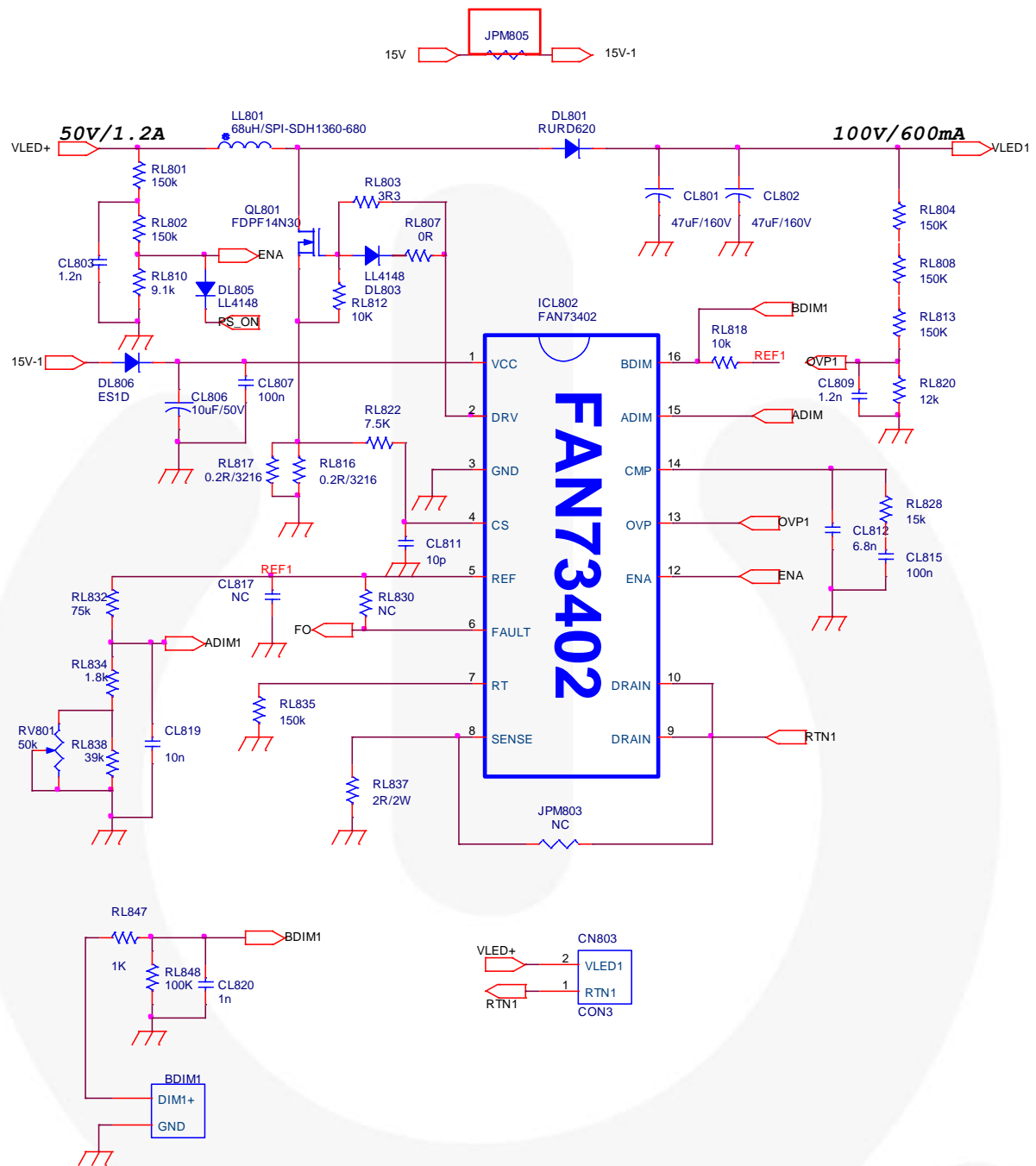

Figure 12. Schematic for Boost Channel 1.

※ JPM805 should be opened in case of 50 V/2.4 A output and shorted in case of 100 V/1.2 A output.

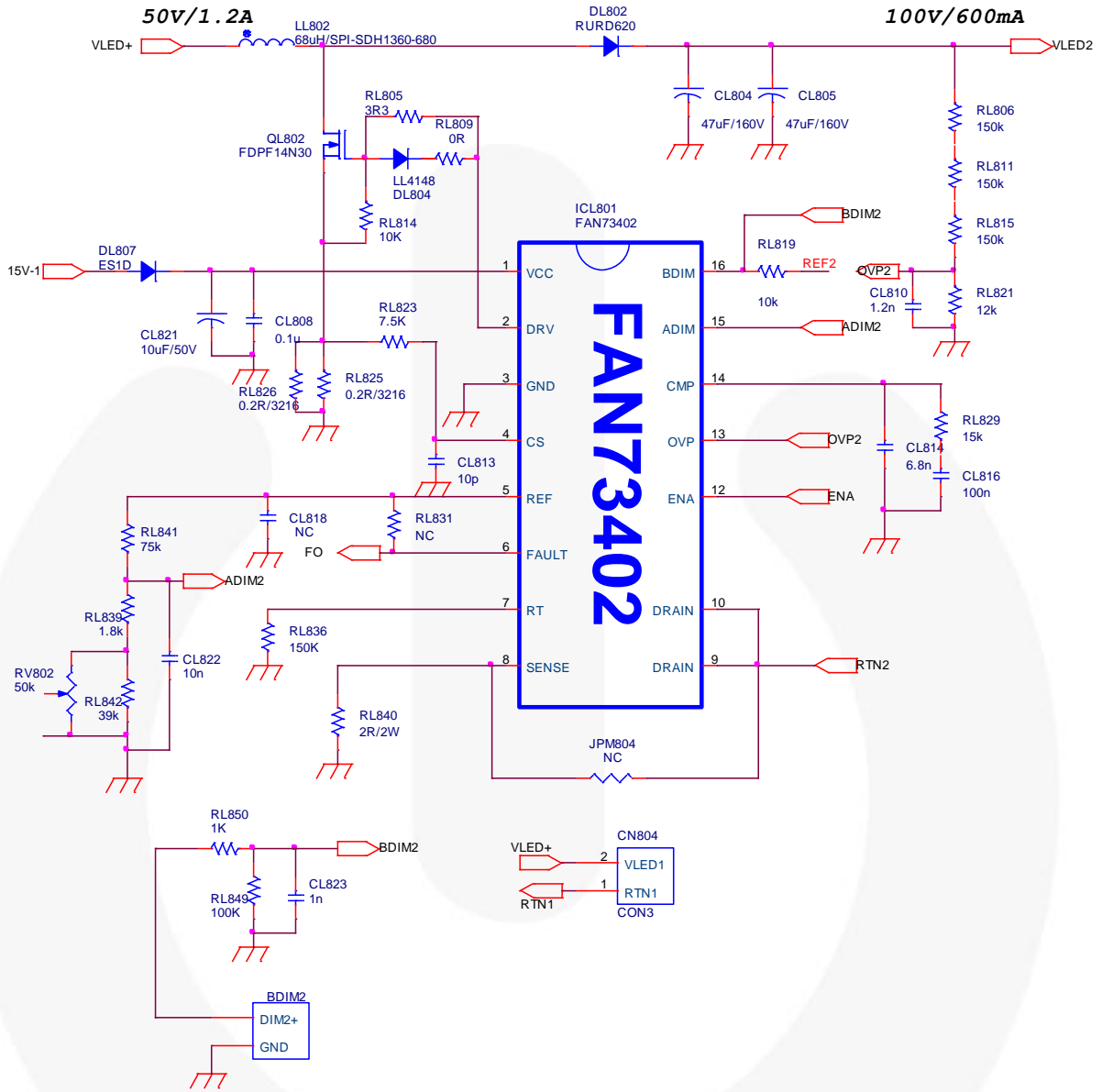

Figure 13. Schematic for Boost Channel 2

6. Bill of Materials

No.	Part Reference	Part Value	Qty.	Description	Vendor
1	BDIM1, BDIM2	2 Pin	1	2 Pin Connector	Molex
2	CL801, CL802, CL804, CL805	47 μ F/160 V	4	Electrolytic Capacitor	Samyoung
3	CL803, CL809, CL810	C0805C112J5GACTU	3	1.2 nF/50 V, SMD MLCC	Kemet
4	CL806, CS808, CS814, CL821	KMG 10 μ F/35 V	4	Electrolytic Capacitor	Samyoung
5	CP806, CS807, CL807, CS809, CS810, CS811, CM811, CS812, CS815, CL815, CL816, CM818, CL808	C0805C104J5GACTU	13	1.2 nF/50 V, SMD MLCC	Kemet
6	CL811, CL813, CM814	C0805C100J5GACTU	3	10 pF/50 V, SMD MLCC	Kemet
7	CL812, CL814	C0805C683J5GACTU	2	6.8 nF/50 V, SMD MLCC	Kemet
8	CM807, CM810, CL819, CL822	C0805C103J5GACTU	4	10 nF/50 V, SMD MLCC	Kemet
9	CP809, CP811, CL820, CL823	C0805C102J5GACTU	4	1 nF/50 V, SMD MLCC	Kemet
10	CM801, CM802, CM803, CM804	NHL 330 μ F/250V	4	Electrolytic Capacitor	Samyoung
11	CM806	C0805C224J5GACTU	1	220 nF/50 V, SMD MLCC	Kemet
12	CM808	C0805C474J5GACTU	1	470 nF/50 V, SMD MLCC	Kemet
13	CM809	C0805C473J5GACTU	1	47 nF/50 V, SMD MLCC	Kemet
14	CM816	4.7 nF/630 V	1	Film Capacitor	Sungho
15	CM817, CM820	C0805C822J5GACTU	2	8.2 nF/50 V, SMD MLCC	Kemet
16	CM823	C0805C562J5GACTU	1	5.6 nF/50 V, SMD MLCC	Kemet
17	CM824	C1206C473J1GACTU	1	47 nF/100 V, SMD MLCC	Kemet
18	CN801	3 Pin	1	3 Pin Connector	Molex
19	CN802, CN803, CN804, CN805	2 Pin	4	2 Pin Connector	Molex
20	CP801, CP802	KMG 330 μ F/250 V	2	Electrolytic Capacitor	Samyoung
21	CP803	680 n/630 V	1	Film Capacitor	Sungho
22	CP805, CM812, CS813	KMG 10 μ F/35 V	3	Electrolytic Capacitor	Samyoung
23	CP807	C0805C204J5GACTU	1	200 nF/50 V, SMD MLCC	Kemet
24	CP808	C0805C105J5GACTU	1	1 μ F/50 V, SMD MLCC	Kemet
25	CS802	C1206C202J5GACTU	1	2.2 nF/630 V, SMD MLCC	Kemet
26	CS803	KMG 47 μ F/35 V	1	Electrolytic Capacitor	Samyoung
27	CS804	KMG 470 μ F/35 V	1	Electrolytic Capacitor	Samyoung

No.	Part Reference	Part Value	Qty.	Description	Vendor
28	CS806	C1206C823J5GACTU	1	82 nF/50 V, SMD MLCC	Kemet
29	CX801, CX802	MPX334	2	X-Capacitor	Carli
30	CY801, CY802	SDC471J10FS10	2	Y-Capacitor	Samwha
31	CY803, CY806	SDC472J10FK7	1	Y-Capacitor	Samwha
32	DL801, DL802	RURD620	2	200 V/6 A Ultrafast Diode	Fairchild Semiconductor
33	DM803, DL803, DP804, DL804, DM805, DL805, DM806, DM807, DM808, DM809	LL4148	10	Small Signal Diode	Fairchild Semiconductor
34	DS801, DP803, DL806, DL807, DM810	ES1D	5	200 V/1 A, Ultra-Fast Diode	Fairchild Semiconductor
35	DM801, DM802	MBR20200CT	2	200 V/20 A, Schottky Rectifier	Fairchild Semiconductor
36	DM804	UF4004	1	400 V/1.0 A, Ultra-Fast Diode	Fairchild Semiconductor
37	DP801	1N5408	1	1000 V/3 A, General Rectifier	Fairchild Semiconductor
38	DP802	FFPF08H60S	1	8 A, 600 V, Hyper-Fast Diode	Fairchild Semiconductor
39	DS802	RS1M	1	1000 V/1 A, Ultra-Fast Diode	Fairchild Semiconductor
40	DS803	SB560	1	60 V/5 A, Schottky Rectifier	Fairchild Semiconductor
41	DS804	1N4003	1	Ultra-Fast Diode	Fairchild Semiconductor
42	DX801	D15XB60	1	600 V 15 A, Bridge Diode	Shindengen
43	FS801	SS-5-3.15 A	1	250 V/3.15 A, Fuse	Bussmann
44	HS1	150 mm	1	Heat Sink [Primary]	
45	HS2	50 mm	1	Heat Sink [Secondary]	
46	ICL801, ICL802	FAN73402	2	LED Boost Switch	Fairchild Semiconductor
47	ICM801	FAN7631	1	LLC Controller	Fairchild Semiconductor
48	ICM803	TSM103W	1	Dual OP-Amp	ST
49	ICP801	FL7930C	1	PFC Controller	Fairchild Semiconductor
50	ICS802	FSL117MRIN	1	Green Mode FPS	Fairchild Semiconductor
51	ICS803	KA431SMF2TF	1	Shunt Regulator	Fairchild Semiconductor
52	ICS804, ICS805	KA78L15	2	15 V Voltage Regulator	Fairchild Semiconductor
53	JPM805	JUMPER	1	Jumper	Molex
54	LL801, LL802	68 μ H/SPI-SDH1360-680	2	68 μ H, SMD Inductor	TDK

No.	Part Reference	Part Value	Qty.	Description	Vendor
55	LP801	PFC3819QM	1	300 μ H, PFC Inductor	TDK
56	LX801, LX802	CV630055	2	Line Filter	TNC
57	PCM801, PCS801, PCS802	FOD817B	3	Opto-Coupler	Fairchild Semiconductor
58	QL801, QL802	FDPF14N30	2	300 V/14 A MOSFET	Fairchild Semiconductor
59	QM801, QM802	FCPF600N60Z	2	600 V/R _{DS(on)} :0.19 Ω , MOSFET	Fairchild Semiconductor
60	QP802	FCPF190N60E	1	600 V/R _{DS(on)} :0.6 Ω , MOSFET	Fairchild Semiconductor
61	QS801, QS853	KSPT2907A	2	PNP Transistor	Fairchild Semiconductor
62	QS802, QS803, QS854	KST2222AMTF	3	NPN Transistor	Fairchild Semiconductor
63	RL801, RL802, RL804, RL806, RL808, RL811, RL815, RL835, RL836, RL813	RC0805JR-07150KL	10	150 k Ω , 2012 SMD	Yageo
64	RL803, RL805	RC0805JR-073R3L	2	3.3 Ω , 2012 SMD	Yageo
65	RL807, RL809, JPM801, JPM802, RS812	RC0805JR-070RL	5	0 Ω , 2012 SMD	Yageo
66	RL810	RC0805JR-079k1L	1	9.1 k Ω , 2012 SMD	Yageo
67	RP805, RM809, RP812, RL812, RL814, RL818, RL819, RM823, RM839, RS855, RS858	RC0805JR-0710kL	11	10 k Ω , 2012 SMD	Yageo
68	RL816, RL817, RL825, RL826	RC1206JR-070R2L	4	0.2 Ω , 3216 SMD	Yageo
69	RS811, RL820, RL821, RM830	RC0805JR-0712kL	4	12 k Ω , 2012 SMD	Yageo
70	RL822 RL823	RC0805JR-077k5L	2	7.5 k Ω , 2012 SMD	Yageo
71	RM828, RL828, RL829, RS856, RS857	RC0805JR-0715kL	5	15 k Ω , 2012 SMD	Yageo
72	RL832, RL841	RC0805JR-0775kL	2	75 k Ω , 2012 SMD	Yageo
73	RL834, RL839	RC0805JR-071k8L	2	1.8 k Ω , 2012 SMD	Yageo
74	RL837, RL840	2 Ω /2 W	2	2 Ω , 2 W Resistor	Abel
75	RM827, RL838, RM841, RL842	RC0805JR-0739kL	4	39 k Ω , 2012 SMD	Yageo
76	RS808, RS815, RM826, RL847, RL850	RC0805JR-071kL	5	1 k Ω , 2012 SMD	Yageo
77	RM821, RL848, RL849	RC0805JR-07100kL	3	100 k Ω , 2012 SMD	Yageo
78	RM801, RM802	0.2 Ω /1 W	2	0.2 Ω , 1 W Resistor	Abel
79	RM803	RC0805FR-0727kL	1	27 k Ω /F, 2012 SMD	Yageo
80	RM805	RC0805JR-071ML	1	1 M Ω , 2012 SMD	Yageo
81	RM806	RC0805JR-071k1L	1	1.1 k Ω , 2012 SMD	Yageo
82	RM807	RC0805FR-0724kL	1	24 k Ω /F, 2012 SMD	Yageo
83	RM808, RM813	RC0805JR-072M2L	2	2.2M Ω , 2012 SMD	Yageo
84	RM810	RC0805FR-072k7L	1	2.7 k Ω /F, 2012 SMD	Yageo
85	RM811, RS814	RC0805JR-074k7L	2	4.7 k Ω , 2012 SMD	Yageo
86	RM812, RM822, RP815	RC0805JR-073R3L	3	3.3 Ω , 2012 SMD	Yageo
87	RM814	RC0805JR-075k6L	1	5.6 k Ω , 2012 SMD	Yageo

No.	Part Reference	Part Value	Qty.	Description	Vendor
88	RM817	RC1206JR-0710RL	1	10 Ω, 2012 SMD	Yageo
89	RM820	RC0805JR-0724kL	1	24 kΩ, 2012 SMD	Yageo
90	RM825	RC1206JR-071kL	1	1 kΩ, 3216 SMD	Yageo
91	RS816, RS817, RS818, RS819, RS820, RM829	RC0805JR-0720kL	6	20 kΩ, 2012 SMD	Yageo
92	RS809, RM832, RM838	RC0805JR-075k1L	3	5.1 kΩ, 2012 SMD	Yageo
93	RM833, RM840	RC1206JR-0718kL	2	18 kΩ, 2012 SMD	Yageo
94	RM836	RC0805JR-072k2L	1	2.2 kΩ, 2012 SMD	Yageo
95	RM837	RC0805FR-0710kL	1	10 kΩ/F, 2012 SMD	Yageo
96	RM840	RC0805FR-072k2L	1	2.2 kΩ/F, 2012 SMD	Yageo
97	RP801, RP804, RP807, RP809	RC0805JR-074M3L	4	4.3 MΩ, 2012 SMD	Yageo
98	RP803	RC0805JR-0710RL	1	10 Ω, 2012 SMD	Yageo
99	RP806	RC0805JR-0747kL	1	47 kΩ, 2012 SMD	Yageo
100	RP811	RC0805JR-07150L	1	150 Ω, 2012 SMD	Yageo
101	RP813	RC0805JR-0791kL	1	91 kΩ, 2012 SMD	Yageo
102	RP814	0.1 Ω/5 W	1	0.1 Ω, 5 W Resistor	Abel
103	RP816	RC0805JR-074K7L	1	4.7 kΩ, 2012 SMD	Yageo
104	RS804, RS805	RC1206JR-07100kL	2	100 kΩ, 3216 SMD	Yageo
105	RS806, RS821, RS822, RS823	RC1206JR-0730kL	4	30 kΩ, 3216 SMD	Yageo
106	RS807	RC1206JR-070RL	1	0 Ω, 3216 SMD	Yageo
107	RS810	RC0805JR-071k5L	1	1.5 kΩ, 2012 SMD	Yageo
108	RS824, RS835	RC1206JR-07120L	1	390 Ω, 3216 SMD	Yageo
109	RT1, RT2	3D15	2	NTC Thermistor	Daekwang S
110	RV801, RV802	50 kΩ/0.5 W	2	50 kΩ, Variable Resistor	Vishay
111	RX801, RX802, RX803	RC1206JR-071ML	3	1 MΩ, 3216 SMD	Yageo
112	SW1	Toggle Switch	1	3 Terminal Switch	Phonix
113	TM801	SRX43EM	1	LLC Transformer	TDK
114	TS801	EPC1717	1	LLC Transformer	TDK
115	ZNR801	10D561K	1	MOV	Samwha
116	CL817, CL818, CM805, CS805	NC	4		
117	RS813, RP817, JPM803, JPM804, RL830, RL831	NC	6		
118	ZDP801	NC	1		

7. Transformer Design

7.1. Flyback Transformer (TS801)

- Core: EPC1717 (TDK)
- Bobbin: 10 Pin

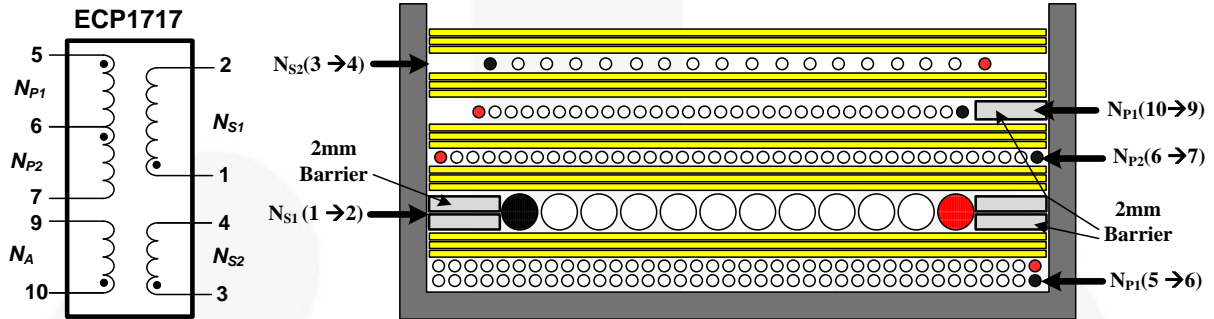

Figure 14. Transformer Pin Assignment and Configuration

Table 2. Winding Specifications

No.	Winding	Pin (S → F)	Wire	Turns	Winding Method
1	N_{P1}	5 → 6	0.15φ	100 Ts	Solenoid Winding
2	Insulation: Polyester Tape t = 0.025 mm, 3-Layer				
3	N_{S1}	1 → 2	0.45φ	12 Ts	Solenoid Winding
4	Insulation: Polyester Tape t = 0.025 mm, 3-Layer				
5	N_{P2}	6 → 7	0.25φ	44 Ts	Solenoid Winding
6	Insulation: Polyester Tape t = 0.025 mm, 3-Layer				
7	N_A	10 → 9	0.15φ	37 Ts	Solenoid Winding
8	Insulation: Polyester Tape t = 0.025 mm, 3-Layer				
9	N_{S2}	3 → 4	0.25φ	22 Ts	Solenoid Winding
10	Insulation: Polyester Tape t = 0.025 mm, 3-Layer				

Table 3. Electrical Characteristics

	Pin	Specifications	Remark
Inductance [Lp]	5 – 7	900 μH ±10%	60 kHz, 1 V
Leakage [LI]	5 – 7	55 μH	60 kHz, 1 V at Short All Output Pins

7.2. PFC Inductor (LP801)

- Core: PFC3819QM(TDK)
- Bobbin: PQM3819, 8 Pin

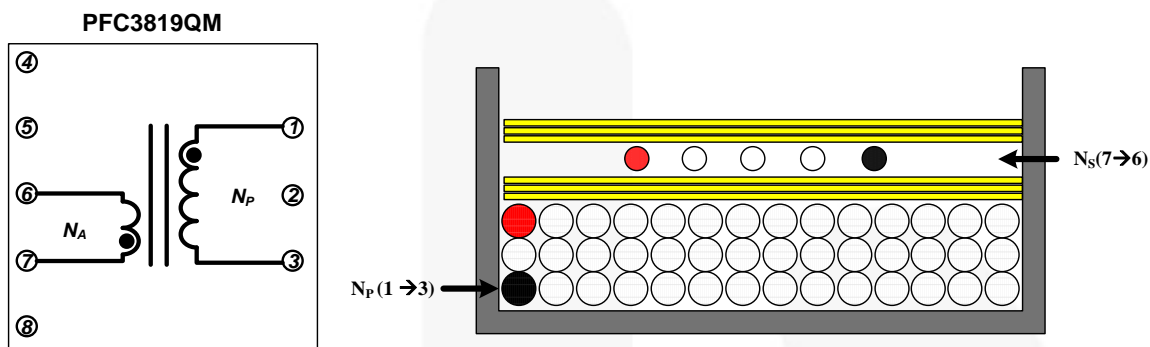

Figure 15. Transformer Pin Assignment and Configuration

Table 4. Winding Specifications

No.	Winding	Pin (S → F)	Wire	Turns	Winding Method
1	N_p	1 → 3	0.1*65[Litz]	40 Ts	Solenoid Winding
2	Insulation: Polyester Tape t = 0.025 mm, 3-Layer				
3	N_{s1}	7 → 6	0.45φ	4 Ts	Solenoid Winding
4	Insulation: Polyester Tape t = 0.025 mm, 3-Layer				

Table 5. Electrical Characteristics

	Pin	Specifications	Remark
Inductance	1 – 3	300 μ H \pm 10%	60 kHz, 1 V

7.3. LLC Transformer (TM801)

- Core: SRX43EM (TDK)
- Bobbin: EEX4333P12-1, 12 Pin

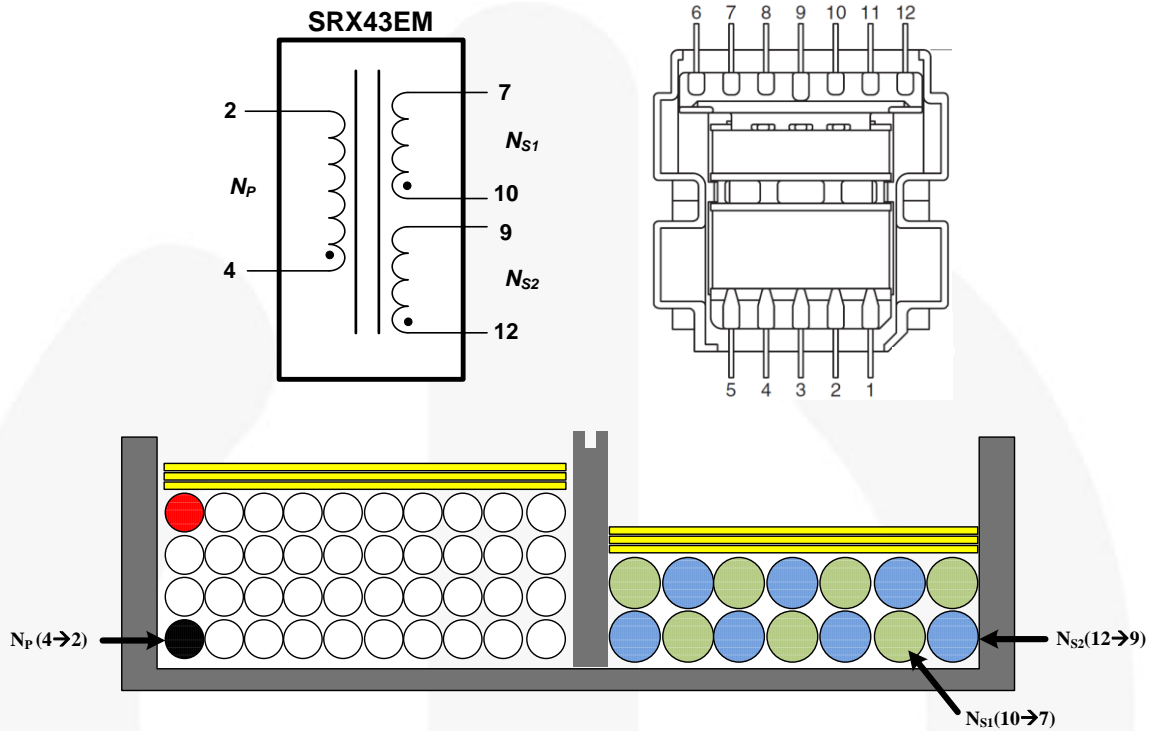

Figure 16. Transformer Pin Assignment and Configuration

Table 6. Winding Specifications

No.	Winding	Pin (S → F)	Wire	Turns	Winding Method
1	N_p	4 → 2	0.1φ * 60 [Litz]]	37 Ts	Solenoid Winding
2	Insulation: Polyester Tape t = 0.025 mm, 3-Layer				
3	N_{S1}	12 → 9	0.08 φ * 120[Litz]]	7 Ts	Solenoid Winding
	N_{S2}	10 → 7		7 Ts	Solenoid Winding
4	Insulation: Polyester Tape t = 0.025 mm, 3-Layer				

Table 7. Electrical Characteristics

	Pin	Specifications	Remark
Inductance [Lp]	4 – 2	810 μH ±10%	100 kHz, 1 V
Leakage [Lr]	5 – 7	105 μH	Short One of the Secondary Windings

8. Performance of Evaluation Board

Table 8. Test Condition & Equipments

Ambient Temperature	$T_A = 25^\circ\text{C}$
Test Equipment	AC Power Source: PCR500L by Kikusui Power Analyzer: PZ4000000 by Yokogawa Electronic Load: PLZ303WH by KIKUSUI Multi Meter: 2002 by KEITHLEY, 45 by FLUKE Oscilloscope: 104Xi by LeCroy Thermometer: Thermal CAM SC640 by FLIR SYSTEMS LED: EHP-AX08EL/GT01H-P03 (3W) by Everlight

8.1. System Efficiency

System efficiency is measured in 85 ~ 140 V_{AC} [low line, 60 Hz] and 180 ~ 300 V_{AC} [high line, 50 Hz] input voltage ranges. The results are for PFC and LLC converters in which a single LED channel can be connected and measured in the rated load condition [50 V/2.5 A] 30 minutes after AC power is turned on.

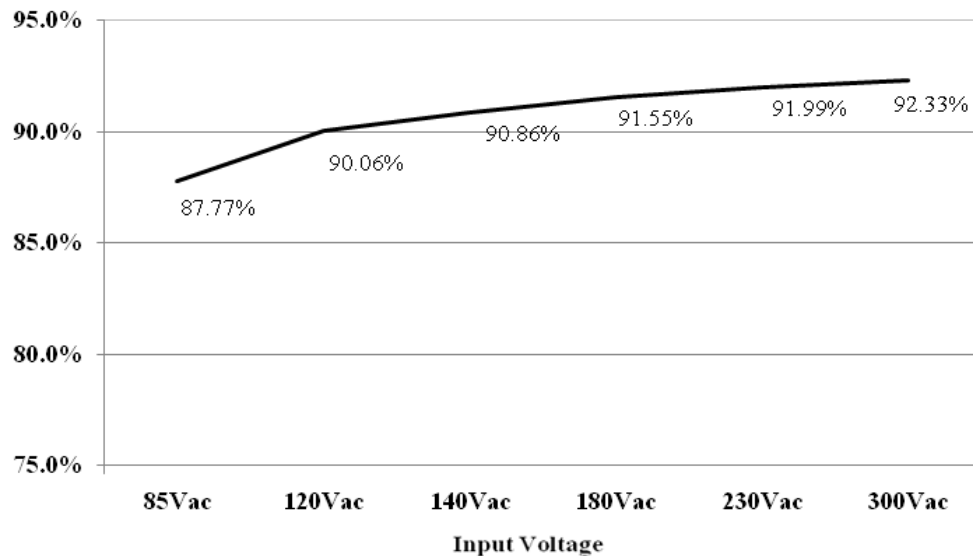

Figure 17. System Efficiency

Table 9. System Efficiency

Input Voltage	Output Voltage[V]	Output Current [A]	Input Power [W]	Output Power [W]	Efficiency
85 V _{AC} [60 Hz]	49.69	2.503	141.70	124.37	87.77%
120 V _{AC} [60 Hz]	49.69	2.503	138.10	124.37	90.06%
140 V _{AC} [60 Hz]	49.69	2.507	137.10	124.57	90.86%
180 V _{AC} [50 Hz]	49.69	2.502	135.80	124.32	91.55%
230 V _{AC} [50 Hz]	49.69	2.503	135.20	124.37	91.99%
300 V _{AC} [50 Hz]	49.69	2.501	134.60	124.27	92.33%

System efficiency is measured in 85 ~ 140 V_{AC} [low line, 60 Hz] and 180 ~ 300 V_{AC} [high line, 50Hz] input voltage ranges. The results are for PFC and LLC converters in which a single LED channel can be connected and measured in the 50% load condition [50 V/1.25 A] 30 minutes after AC power is turned on.

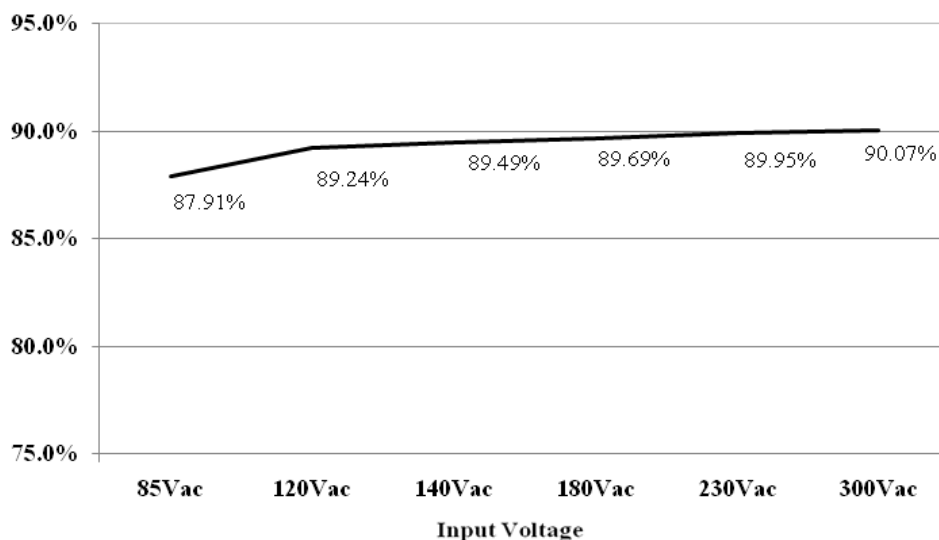

Figure 18. System Efficiency

Table 10. System Efficiency

Input Voltage	Output Voltage[V]	Output Current [A]	Output Voltage [V]	Output Power [W]	Efficiency
85 V _{AC} [60 Hz]	49.71	1.252	70.80	62.24	87.91%
120 V _{AC} [60 Hz]	49.71	1.253	69.80	62.29	89.24%
140 V _{AC} [60 Hz]	49.71	1.253	69.60	62.29	89.49%
180 V _{AC} [50 Hz]	49.71	1.254	69.50	62.34	89.69%
230 V _{AC} [50 Hz]	49.71	1.254	69.30	62.34	89.95%
300 V _{AC} [50 Hz]	49.71	1.252	69.10	62.24	90.07%

Table 11 shows stand-by power consumption of 85 V_{AC}~ 140 V_{AC} [low line, 60 Hz] and 180 ~ 300 V_{AC} [high line, 50 Hz] input voltage ranges. The results are measured when the PS-ON switch is turned off.

Table 11. System Efficiency

Input Voltage	Input Power [W]
85 V _{AC} [60 Hz]	0.283
120 V _{AC} [60 Hz]	0.306
140 V _{AC} [60 Hz]	0.315
180 V _{AC} [50 Hz]	0.319
230 V _{AC} [50 Hz]	0.341
300 V _{AC} [50 Hz]	0.397

8.2. Power Factor and Total Harmonic Discharge (THD)

Power factor and THD were measured in 85 ~ 140 V_{AC} [low line, 60 Hz] and 180 ~ 300 V_{AC} [high line, 50 Hz] input voltage ranges. The measured data were results for the overall system with two channel LED loads connected.

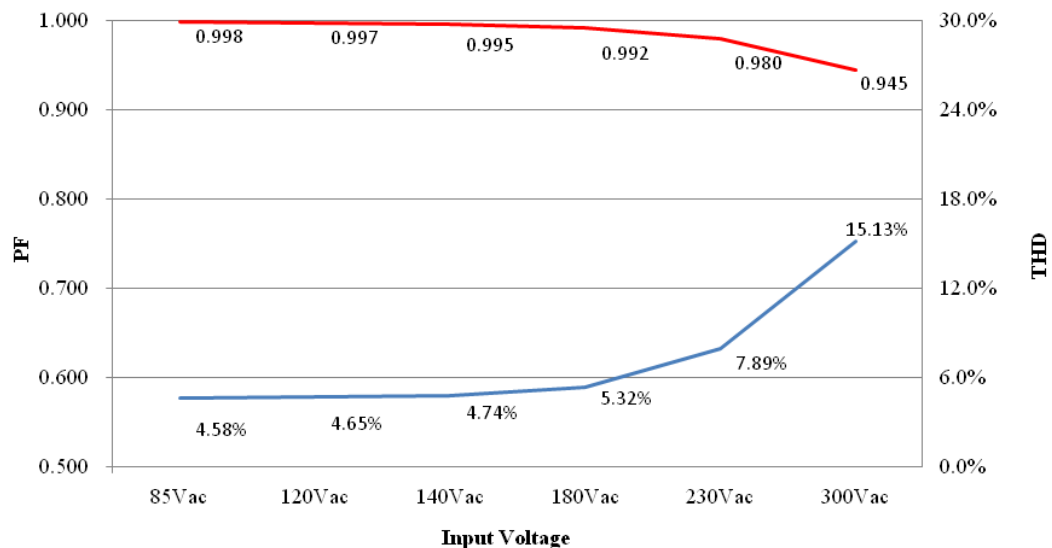

Figure 19. Power Factor & Total Harmonic Distortion

Table 12. Power Factor & Total Harmonic Distortion

Input Voltage	Output Current	Output Voltage	Power Factor	THD
85 V _{AC} [60 Hz]	2.503 A	49.69 V	0.998	4.58%
120 V _{AC} [60 Hz]	2.503 A	49.69 V	0.997	4.65%
140 V _{AC} [60 Hz]	2.507 A	49.69 V	0.995	4.74%
180 V _{AC} [50 Hz]	2.502 A	49.69 V	0.992	5.32%
230 V _{AC} [50 Hz]	2.503 A	49.69 V	0.980	7.89%
300 V _{AC} [50 Hz]	2.501 A	49.69 V	0.945	15.13%

8.3. Constant-Current and Voltage Regulation

Table 13 and Figure 20 show the typical CC/CV performance on the board; showing very stable CC performance over a wide input range. The results are for PFC and LLC converters with a single LED channel connected and measured with E-Load [CR Mode].

Table 13. Constant-Current Regulation by Output Voltage Change (25 V~ 50 V)

Input Voltage	Min.		Max.		CV	CC
	V _{OUT} [V]	I _{OUT} [mA]	V _{OUT} [V]	I _{OUT} [mA]		
85 V _{AC} / 60 Hz	49.60	2552	49.70	2560	±0.03%	±0.04%
120 V _{AC} / 60 Hz	49.60	2552	49.70	2560	±0.03%	±0.04%
230 V _{AC} / 50 Hz	49.70	2552	49.90	2560	±0.05%	±0.04%
300 V _{AC} / 50 Hz	49.70	2552	49.90	2560	±0.05%	±0.04%

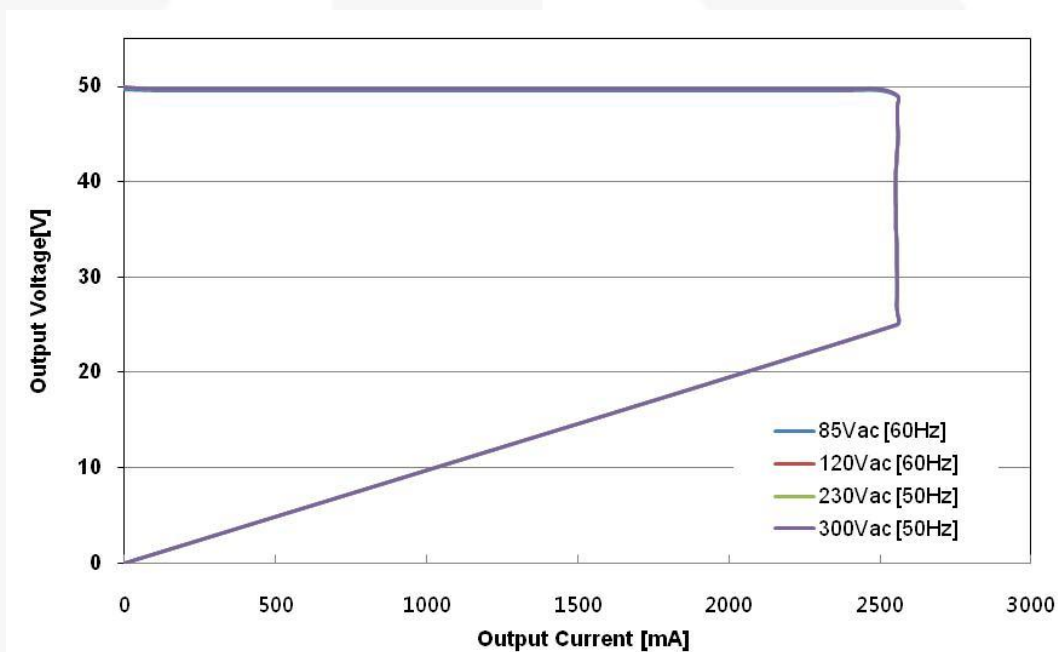

Figure 20. Constant-Current Regulation, Measured by E-Load [CR Mode]

8.4. Overall Startup Performance

Figure 21 and Figure 22 show the startup performance; including flyback, boost, LLC resonant converter, and single-channel boost converter at rated output load. The output load current starts flowing after about 469 ms and 340 ms for input voltage 85 V_{AC} and 300 V_{AC} condition when the AC input power switch turns on; CH1: V_{DD_Flyback} (10 V / div), CH2: V_{IN} (200 V / div), CH3: V_{LED} (50 V / div), CH4: I_{LED} (0.5 A / div), Time Scale: 200 ms / div.

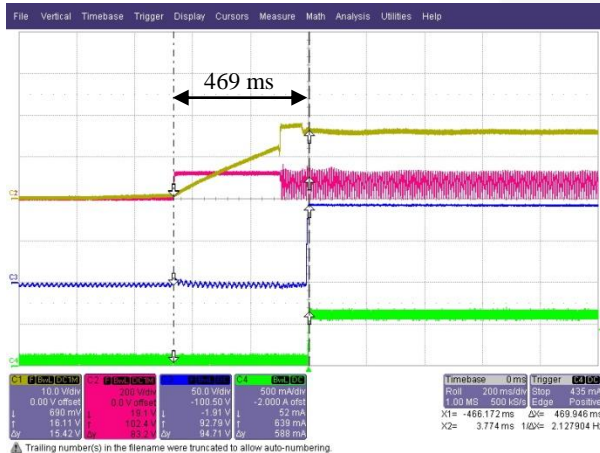

Figure 21. V_{IN} = 85 V_{AC} / 60 Hz

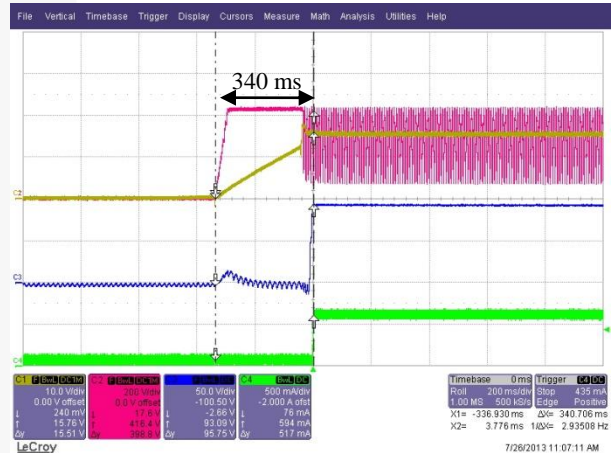

Figure 22. V_{IN} = 300 V_{AC} / 50 Hz

Figure 23 and Figure 24 show the startup and stop performance for the PS-ON switch operation; including boost, LLC resonant converter, and single-channel boost converter. The output load current starts flowing about 59 ms after the PS-ON switch was turned on and is disconnected when the PS-ON switch was turned off in standby status; CH1: V_{DD_PFC} (10 V / div), CH2: V_{PS-ON} (2 V / div), CH3: V_{LED} (50 V / div), CH4: I_{LED} (0.5 A / div).



Figure 23. PS-ON [100 ms/div]

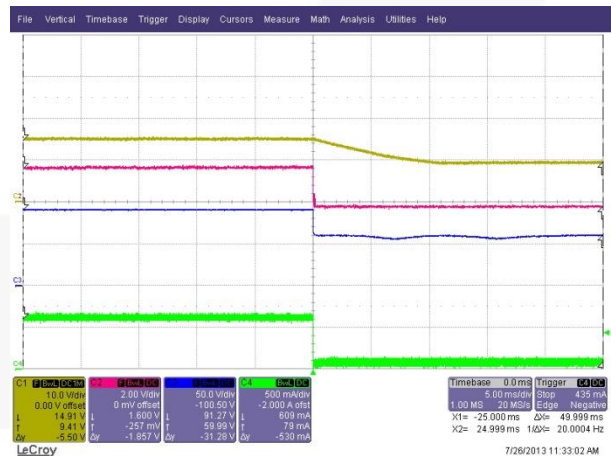

Figure 24. PS-OFF [5 ms/div]

8.5. Startup Performance in Flyback Stage

Figure 25 and Figure 26 show the startup performance of the flyback converter. The output voltage is raised after about 395 ms and 297 ms at 85 V_{AC} and 300 V_{AC} input voltage, respectively, when the AC input power switch turns on; CH1: V_{DD-FLYBACK} (10 V / div), CH2: V_{IN} (200 V / div), CH3: V_{SV} (2 V / div), CH4: V_{DD-FAN73402} (10 V / div), Time Scale: 200 ms / div.

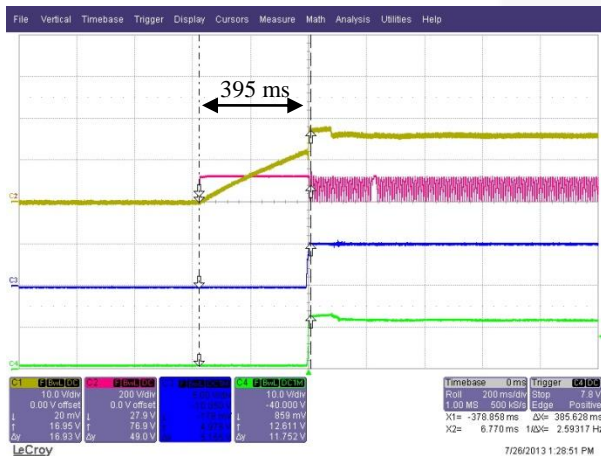

Figure 25. V_{IN} = 85 V_{AC} / 60 Hz

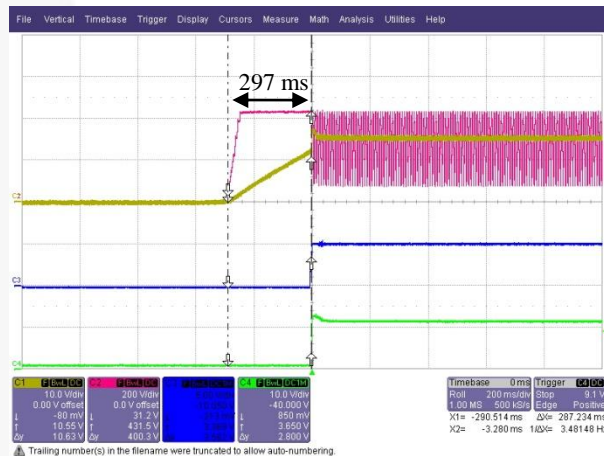

Figure 26. V_{IN} = 300 V_{AC} / 50 Hz

Figure 27 and Figure 28 show the startup and stop performance for the flyback converter according to PS-ON switch operation. Each output voltage is raised at the same time when the PS-ON switch is turned on and V_{DD-FAN73402} drops under UVLO after 100 ms since PS-ON switch was turned off in standby status; CH1: V_{DD-PFC} (10 V / div), CH2: V_{PS-ON} (2 V / div), CH3: V_{SV} (2 V / div), CH4: V_{DD-FAN73402} (10 V / div), Time Scale: 200 ms / div.

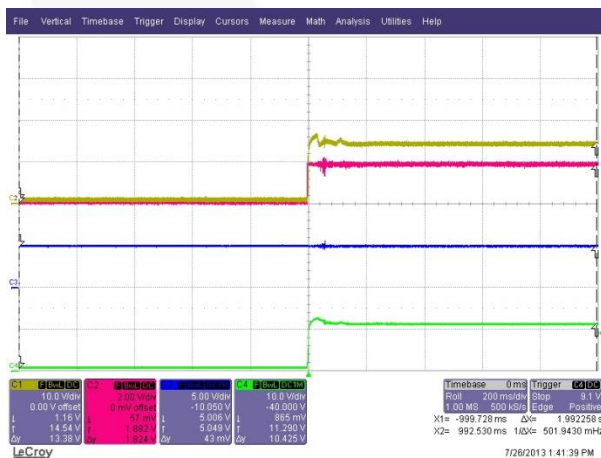

Figure 27. PS-ON

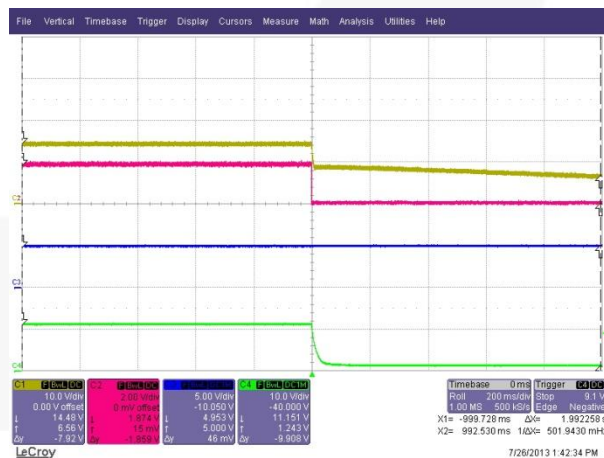

Figure 28. PS-OFF

8.6. Startup Performance in PFC Stage

Figure 29 and Figure 30 show the startup performance; including flyback and boost converter at the rated output load. The PFC output voltage is raised after about 429 ms and 339 ms, respectively, for input voltage 85 V_{AC} and 300 V_{AC} condition when the AC input power switch turns on; CH1: V_{DD-FLYBACK} (10 V / div), CH2: V_{IN} (200 V / div), CH3: V_{OUT_PFC} (200 V / div), CH4: V_{R_{RDY}} (2 V / div), Time Scale: 200 ms / div.

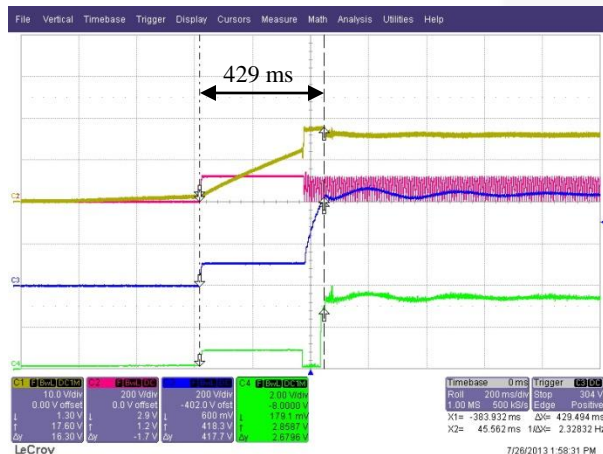

Figure 29. V_{IN} = 85 V_{AC} / 60 Hz

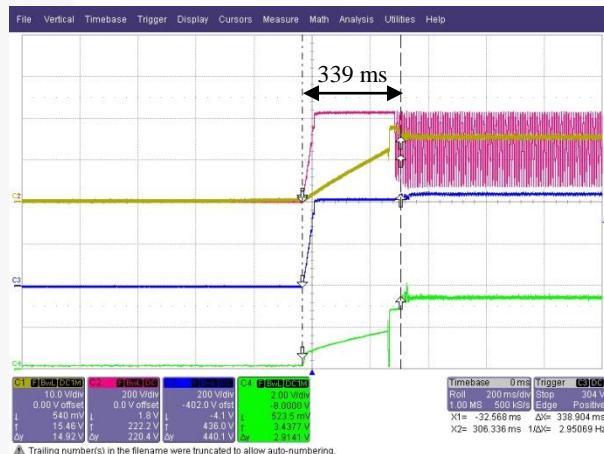

Figure 30. V_{IN} = 300V_{AC} / 50 Hz

Figure 31 and Figure 32 show the startup and stop performance for the boost converter according to PS-ON switch operation at rated output load. The PFC output voltage is raised rapidly when the PS-ON switch is turned on and V_{DD-PFC} drops below UVLO and PFC output starts discharging PFC output capacitors when PS-ON switch was turned off in standby status; CH1: V_{DD-PFC} (10 V / div), CH2: V_{PS-ON} (2 V / div), CH3: V_{OUT-PFC} (200 V / div), CH4: V_{R_{RDY}} (2 V / div).

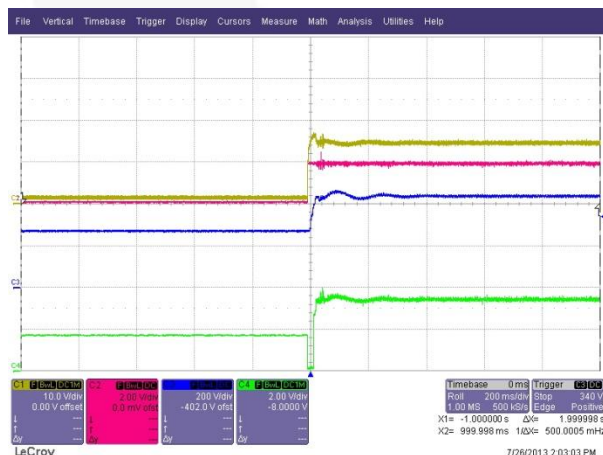

Figure 31. PS-ON, [200 ms/div]



Figure 32. PS-OFF, [500 ms/div]

8.7. Startup Performance in LLC Stage

Figure 33 and Figure 34 show the startup performance; including flyback, boost, and LLC converter. The LLC output voltage is raised after about 455 ms and 337 ms, respectively, for input voltage 85 V_{AC} and 300 V_{AC} condition when the AC input power switch turns on; CH1: V_{DD-FLYBACK} (10 V / div), CH2: V_{IN} (200 V / div), CH3: V_{OUT-LLC} (20 V / div), CH4: I_{OUT-LLC} (2 A / div), Time Scale: 200 ms / div.



Figure 33. V_{IN} = 85 V_{AC} / 60 Hz

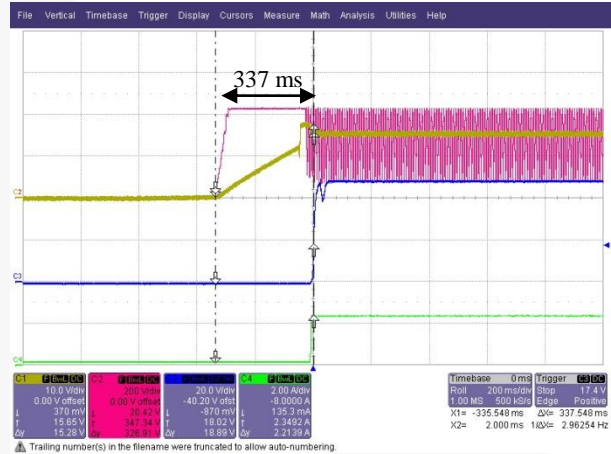

Figure 34. V_{IN} = 300 V_{AC} / 50 Hz

Figure 35 and Figure 36 show the startup and stop performance for the LLC converter according to the PS-ON switch operation at rated output load. The LLC output current is raised up to the rated voltage within 50 ms after the PS-ON switch is turned on and the output current drops to zero quickly when the PS-ON switch is turned off in standby status; CH1: V_{DD-LLC} (10 V / div), CH2: V_{PS-ON} (2 V / div), CH3: V_{OUT-LLC} (20 V / div), CH4: I_{OUT-LLC} (2 A / div), Time Scale: 200 ms / div.

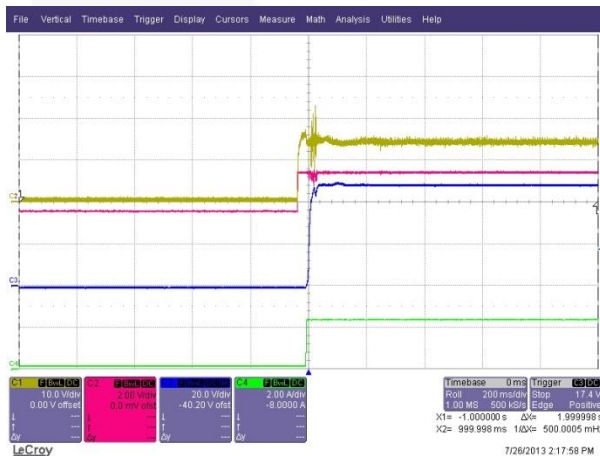

Figure 35. PS-ON

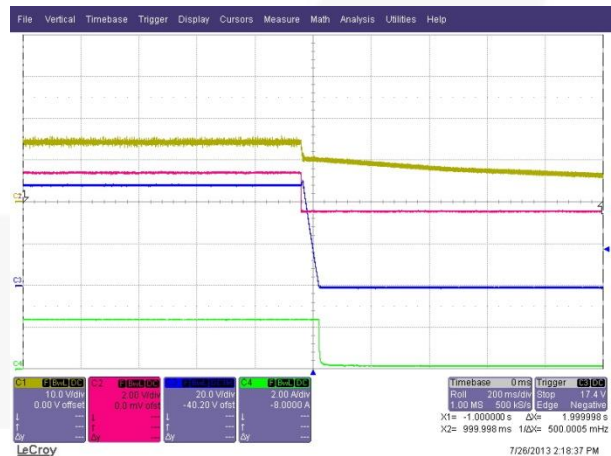

Figure 36. PS-OFF

8.8. Key Waveforms for Input and Output

Figure 37 and Figure 38 show AC input and output waveforms at 85 V_{AC} and 300 V_{AC} line voltage and rated output load condition, respectively; CH1: I_{IN} (5 A / div), CH2: V_{IN} (200 V / div), CH3: V_{LED} (50 V / div), CH4: I_{LED} (0.5 A / div), Time Scale: 5 ms / div.

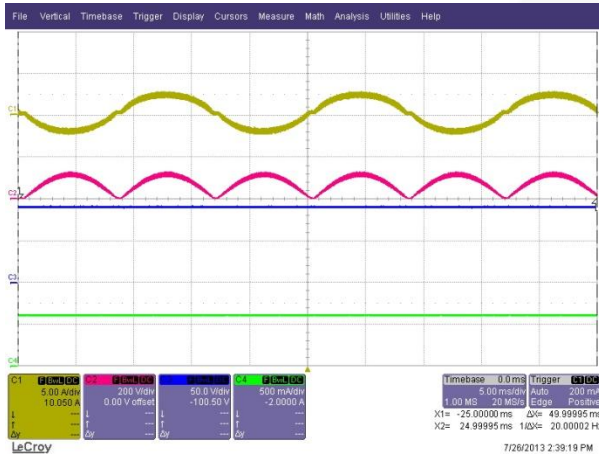

Figure 37. V_{IN} = 85 V_{AC} / 60 Hz, 100% Dim



Figure 38. V_{IN} = 300 V_{AC} / 50 Hz, 100% Dim

Figure 39 and Figure 40 show AC input and output waveforms at 85 V_{AC} and 300 V_{AC} line voltage and 50% output load condition, respectively; CH1: V_{IN} (2 A / div), CH2: V_{IN} (200 V / div), CH3: V_{OUT} (50 V / div), CH4: I_{LED} (0.5 A / div), Time Scale: 5 ms / div.



Figure 39. V_{IN} = 85 V_{AC} / 60 Hz, 50% Dim

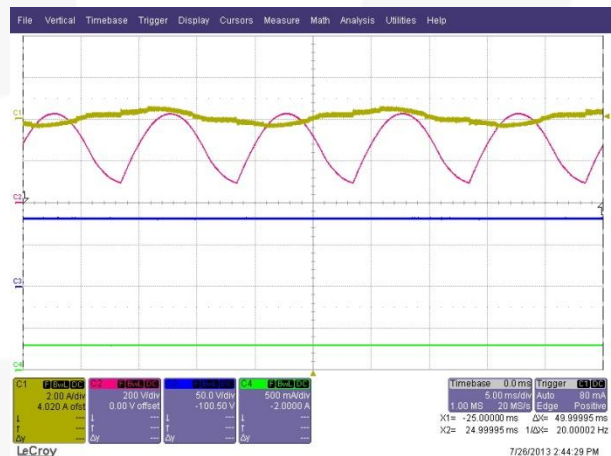

Figure 40. V_{IN} = 300 V_{AC} / 50 Hz, 50% Dim

Figure 41 and Figure 42 show AC input and output waveforms at 85 V_{AC} and 300 V_{AC} line voltage and 10% output load condition, respectively; CH1: V_{IN} (1 A / div), CH2: V_{IN} (200 V / div), CH3: V_{OUT} (50 V / div), CH4: I_{LED} (0.5 A / div), Time Scale: 5 ms / div. In case of 300 V_{AC}, PFC was operated in Burst Mode, so switching pulse were skipped.

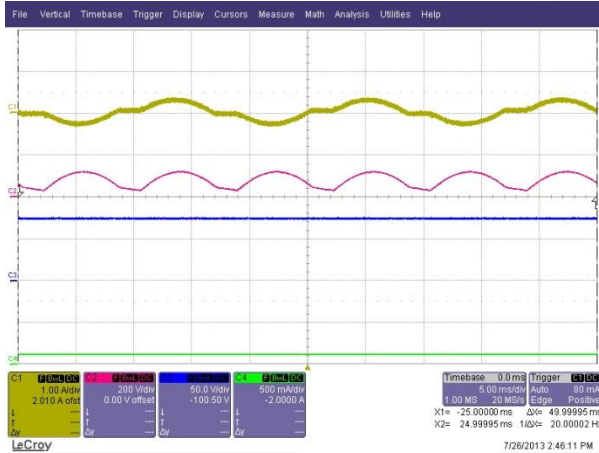

Figure 41. V_{IN} = 85 V_{AC} / 60 Hz, 10% Dim



Figure 42. V_{IN} = 300 V_{AC} / 50 Hz, 10% Dim

8.9. Key Waveforms for Flyback Stage

Figure 43 and Figure 44 show key waveforms of the flyback stage according to the PS-ON switch operation at rated output load condition; CH1: I_{DS-ICS802} (0.5 A / div), CH2: V_{DS-ICS802} (200 V / div), CH3: V_{PS-ON} (2 V / div). Time Scale: 200 ns / div.

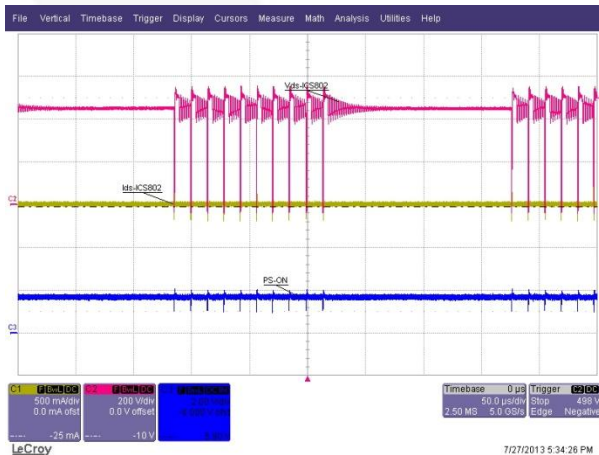

Figure 43. PS-ON

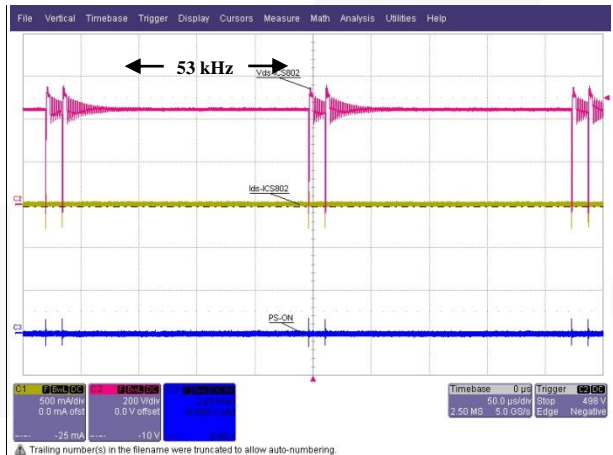

Figure 44. PS-OFF

8.10. Key Waveforms for PFC Stage

Figure 45 and Figure 46 show key waveforms of PFC stage at 85 V_{AC} line voltage and rated output load condition; CH1: I_{DS-QP802} (2 A / div), CH2: V_{DS-QP802} (200 V / div), CH3: V_{AK-DP802} (200 V / div), CH4: I_{AK-DP802} (2 A / div).

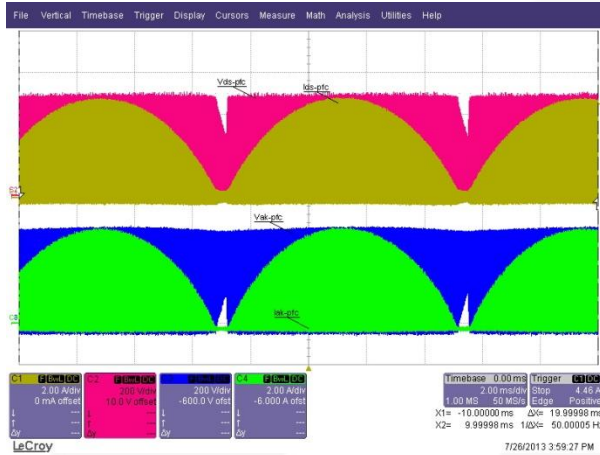

Figure 45. V_{IN} = 85 V_{AC} / 60 Hz, [5 ms/div]

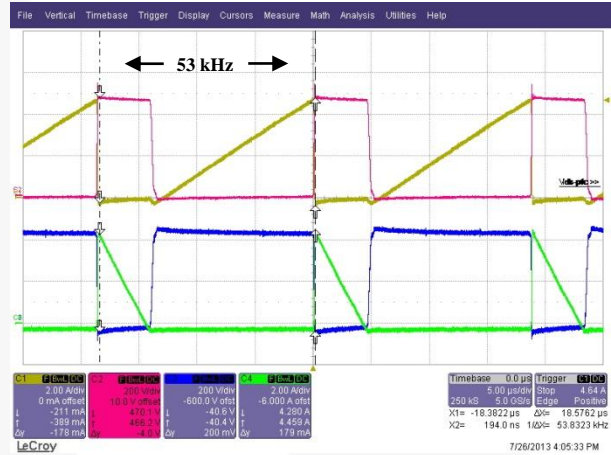

Figure 46. V_{IN} = 85 V_{AC} / 60 Hz, [5 μs/div]

Figure 47 and Figure 48 show key waveforms of PFC stage at 85 V_{AC} line voltage and no-load condition; CH1: I_{DS-QP802} (0.5 A / div), CH2: V_{DS-QP802} (200 V / div), CH3: V_{AK-DP802} (200 V / div), CH4: I_{AK-DP802} (0.5 A / div).

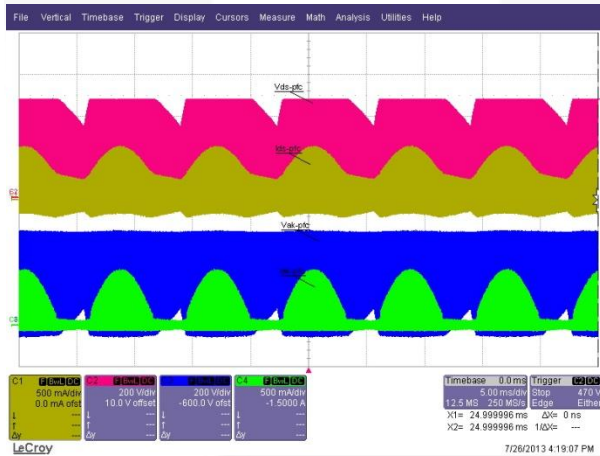

Figure 47. V_{IN} = 85 V_{AC} / 60 Hz, [5 ms/div]

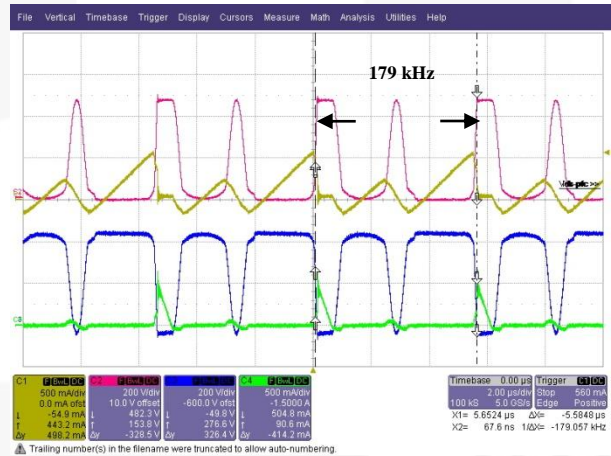

Figure 48. V_{IN} = 85 V_{AC} / 60 Hz, [2 μs/div]

Figure 49 and Figure 50 show key waveforms of the PFC stage at 300 V_{AC} line voltage and rated output load condition; CH1: I_{DS_QP802} (2 A / div), CH2: V_{DS_QP802} (200 V / div), CH3: V_{AK_DP802} (200 V / div), CH4: I_{AK_DP802} (2 A / div).

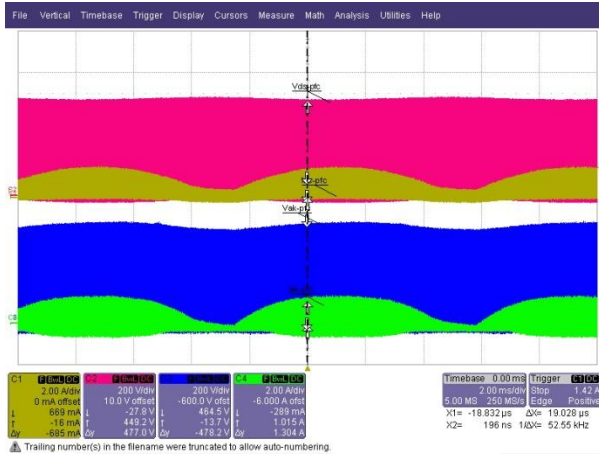

Figure 49. V_{IN} = 300 V_{AC} / 50 Hz, [2 ms/div]

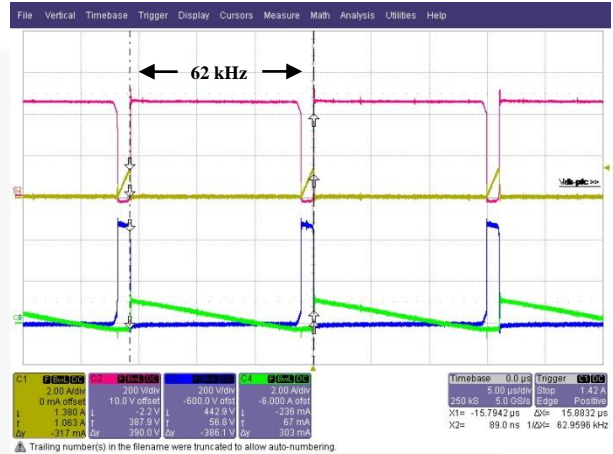

Figure 50. V_{IN} = 300 V_{AC} / 50 Hz, [5 μs/div]

Figure 51 and Figure 52 show key waveforms of the PFC stage at 300 V_{AC} line voltage and no-load condition; CH1: I_{DS_QP802} (0.5 A / div), CH2: V_{DS_QP802} (200 V / div), CH3: V_{AK_DP802} (200 V / div), CH4: I_{AK_DP802} (0.5 A / div).

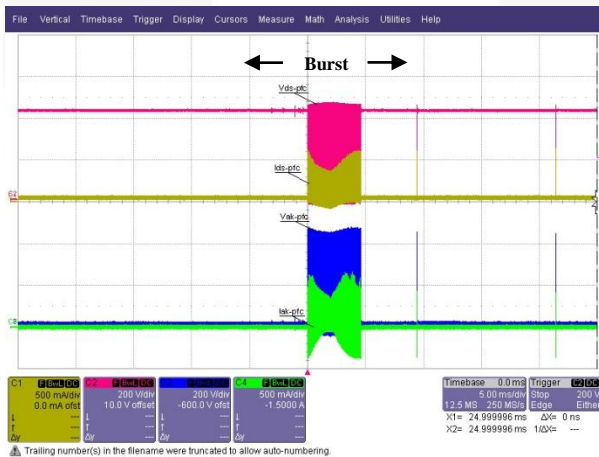

Figure 51. V_{IN} = 300 V_{AC} / 50 Hz, [5 ms/div]

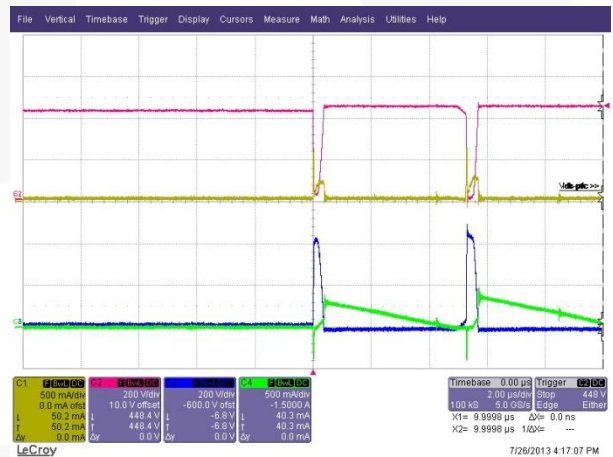

Figure 52. V_{IN} = 300 V_{AC} / 50 Hz, [2 μs/div]

8.11. Key Waveforms for LLC Stage

Figure 53 and Figure 54 show key waveforms in the primary side of the LLC converter at rated output load condition; CH1: $V_{GATE-QM802}$ (10 V / div), CH2: $V_{GATE-QM801}$ (10 V / div), CH3: $V_{Cr-CM816}$ (200 V / div), CH4: $I_{Lr-TM801}$ (1.0 A / div).

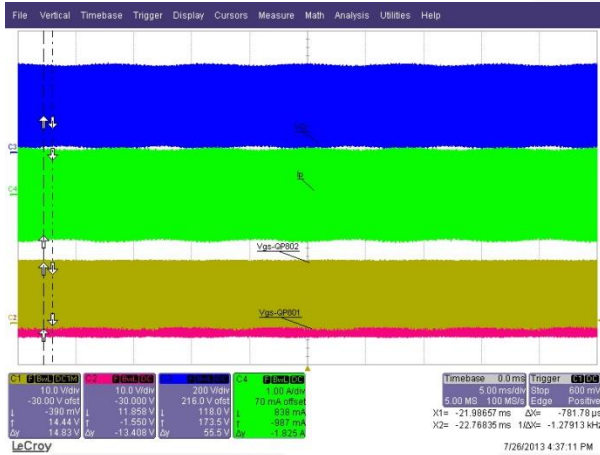

Figure 53. Rated Load [5 ms/div]

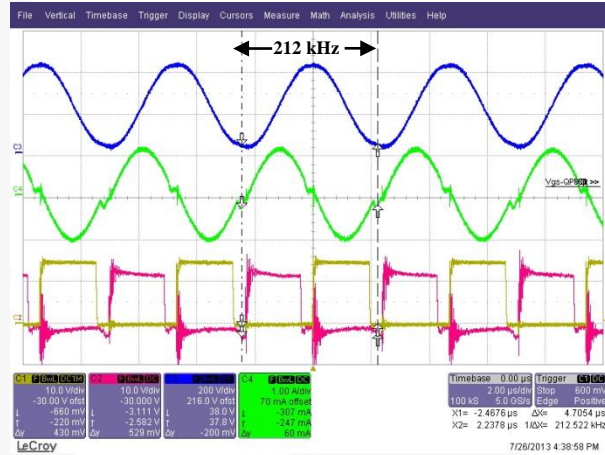

Figure 54. Rated Load [2 μs/div]

Figure 55 and Figure 56 show key waveforms in the secondary side of the LLC converter at rated output load condition; CH1: $I_{Secondary}$ (2.0 A / div), CH2: V_{AK_DM802} (100 V / div), CH3: V_{AK_DM801} (100 V / div).



Figure 55. Rated Load [5 ms/div]

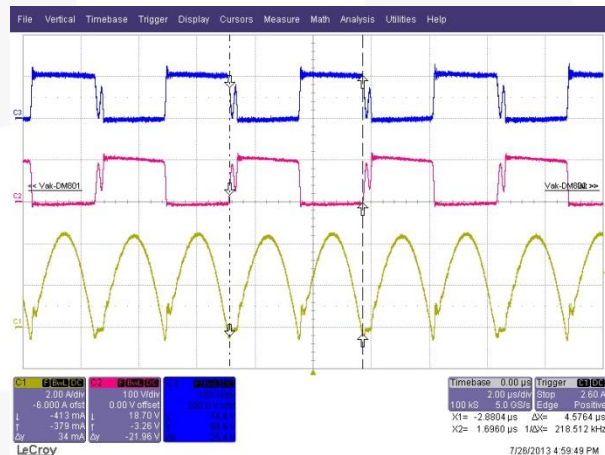

Figure 56. Rated Load [2 μs/div]

Figure 57 and Figure 58 show key waveforms in the primary side of the LLC converter at no-load condition; CH1: V_{GATE_QM802} (10 V / div), CH2: V_{GATE_QM801} (10 V / div), CH3: V_{Cr_CM816} (200 V / div), CH4: I_{Lr_TM801} (1.0 A / div).

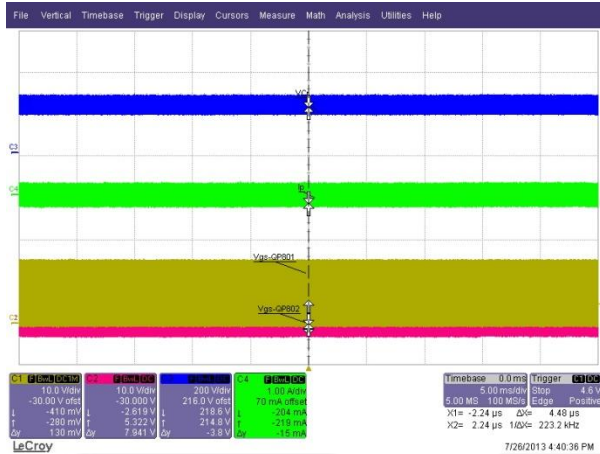

Figure 57. No Load [5 ms/div]

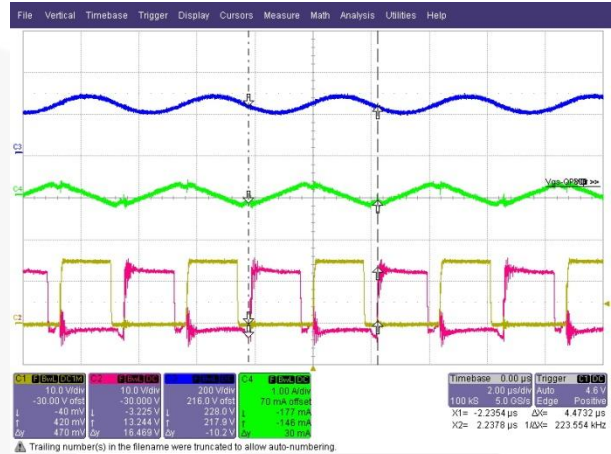

Figure 58. No Load [2 μs/div]

Figure 59 and Figure 60 show key waveforms in the secondary side of the LLC converter at no-load condition; CH1: $I_{Secondary}$ (0.5 A / div), CH2: V_{AK_DM802} (100 V / div), CH3: V_{AK_DM802} (100 V / div).

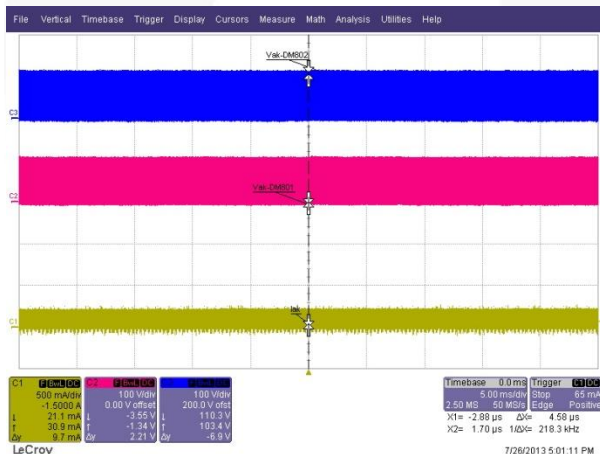

Figure 59. No Load [5 ms/div]

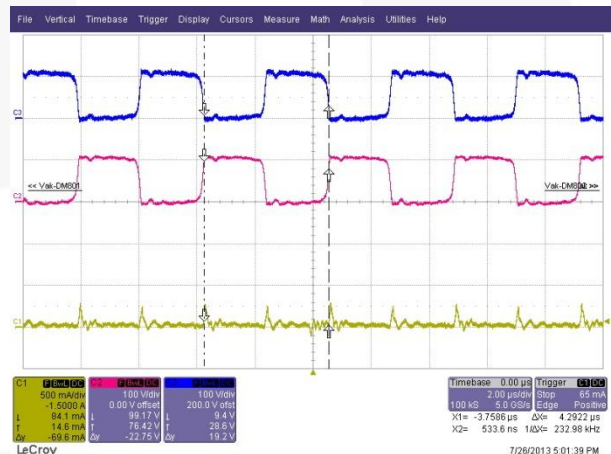

Figure 60. No Load [2 μs/div]

8.12. Key Waveforms for Single-Channel Boost Stage

Figure 61 and Figure 62 show key waveforms of a single-channel boost converter at rated output load condition; CH1: I_{DS_QL802} (2.0 A / div), CH2: V_{DS_QL802} (100 V / div), CH3: V_{AK_DL802} (100V / div), CH4: I_{AK_DL802} (2.0 A / div).



Figure 61. Rated Load [2 ms/div]

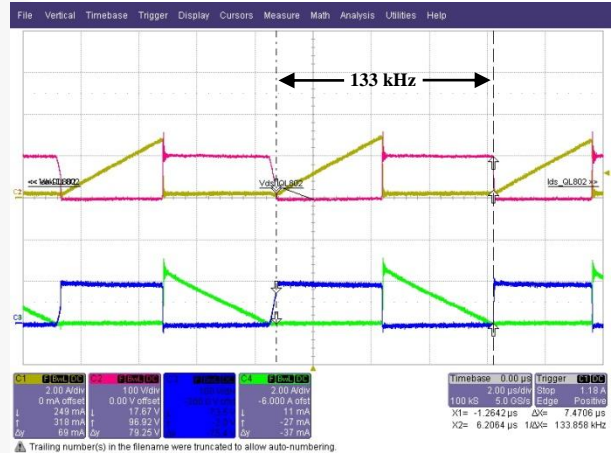

Figure 62. Rated Load [2 us/div]

Figure 63 and Figure 64 show key waveforms of a single-channel boost converter at 10% load condition; CH1: I_{DS_QL802} (2.0 A / div), CH2: V_{DS_QL802} (100 V / div), CH3: V_{AK_DL802} (100 V / div), CH4: I_{AK_DL802} (2.0 A / div).



Figure 63. 10% Load [2 ms/div]

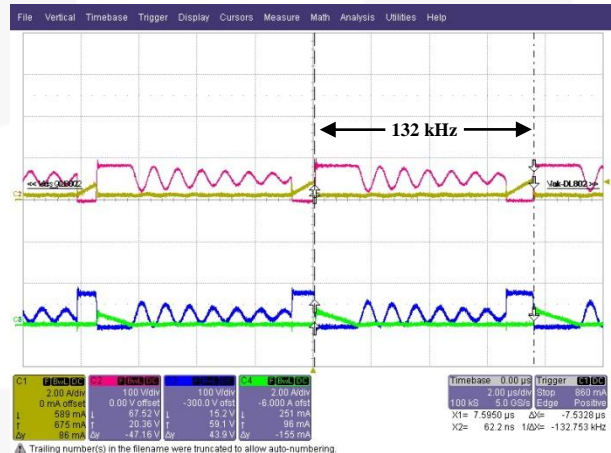

Figure 64. 10% Load [2 us/div]

8.13. Dimming Performance

Figure 65 and Figure 66 show key waveforms for analog dimming performance of a single-channel boost converter at 10% ADIM (V_{ADIM} : 0.12 V) and 100% BDIM; CH1: I_{LED} (0.2 A / div), CH2: $V_{GATE-QL802}$ (5.0 V / div), CH3: V_{BDIM} (5.0 V / div), CH4: V_{ADIM} (0.5 V / div).



Figure 65. 10% ADIM [2 ms/div]

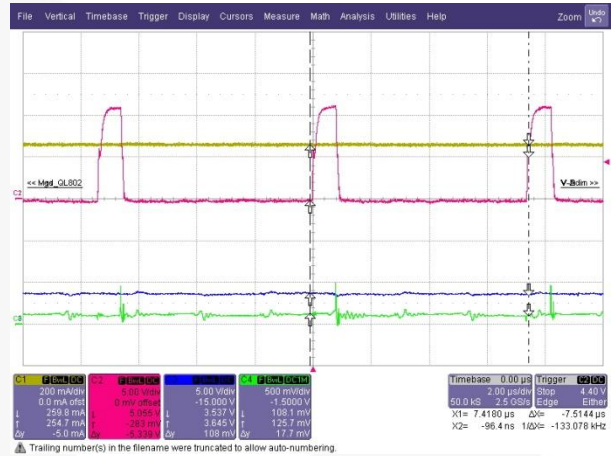

Figure 66. 10% ADIM [2 μs/div]

Figure 67 and Figure 68 show key waveforms for PWM dimming performance of a single-channel boost converter at 100% ADIM (V_{ADIM} : 1.2 V) and 1% BDIM; CH1: I_{LED} (0.5 A / div), CH2: $V_{GATE-QL802}$ (5.0 V / div), CH3: V_{BDIM} (5.0 V / div), CH4: V_{ADIM} (0.5 V / div).

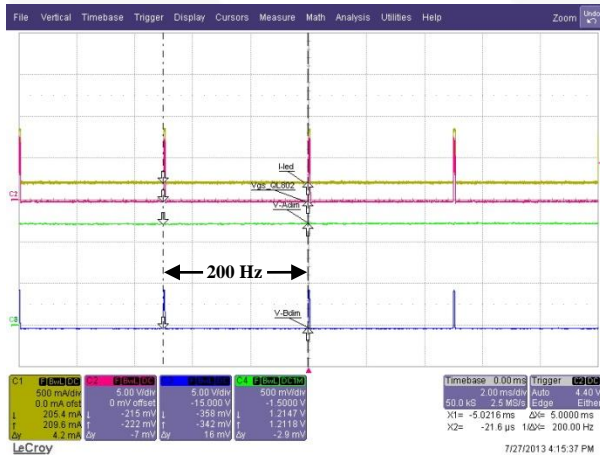

Figure 67. 1% BDIM [2 ms/div]

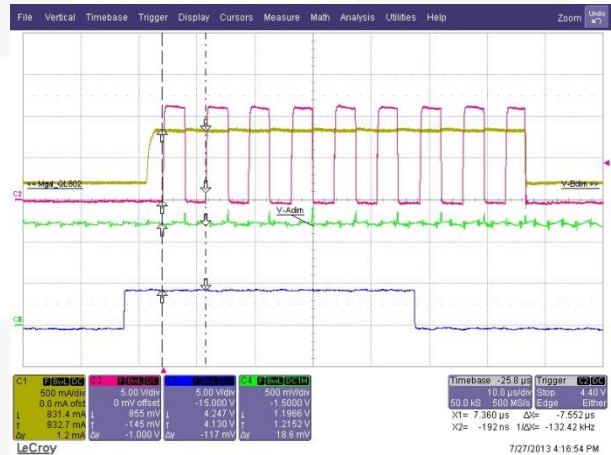

Figure 68. 1% BDIM [10 μs/div]

Figure 69 and Figure 70 show the FAN73402's analog [ADIM] and PWM [BDIM] dimming characteristic curves.

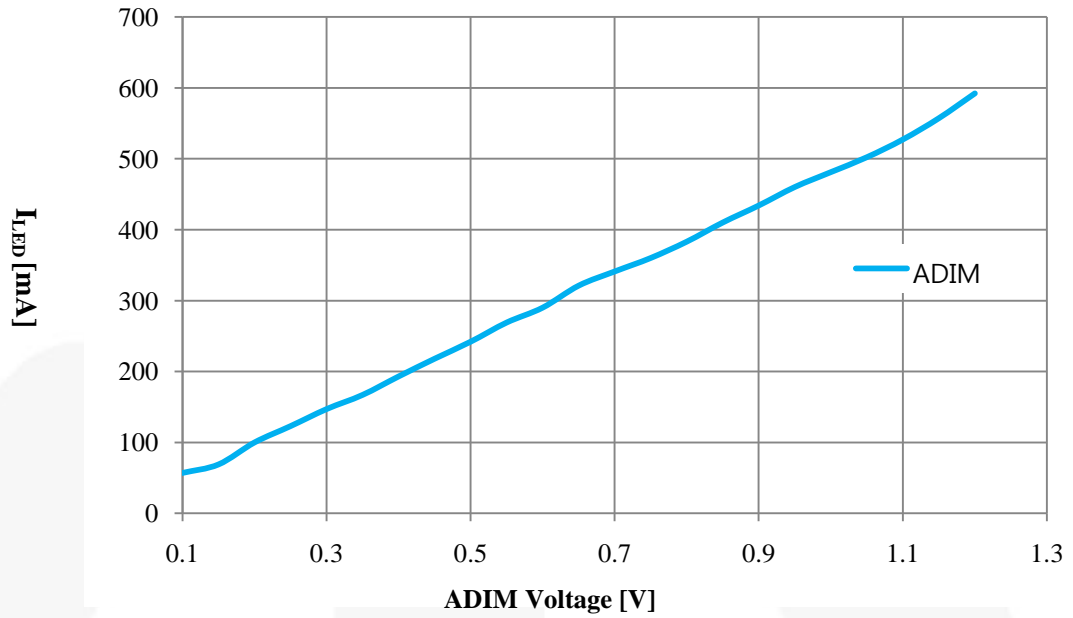

Figure 69. Analog Dimming Characteristics

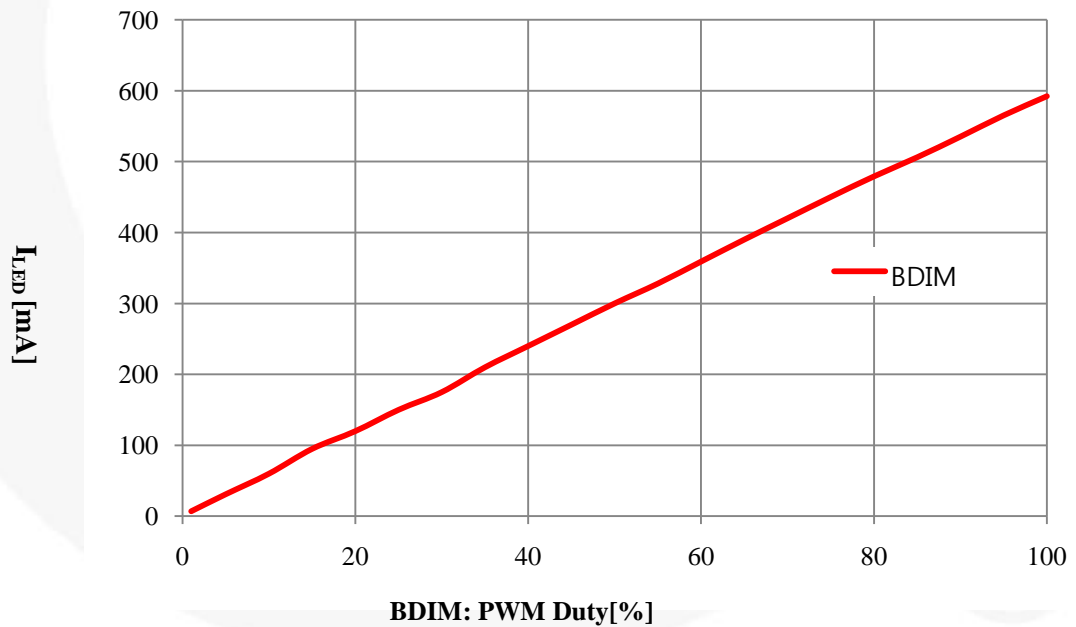

Figure 70. PWM Characteristics

8.14. LED Short / Open Protection at Multi-Channel Output

Figure 71 and Figure 72 show waveforms for output voltage and current when an LED is shorted and recovered in one of the LED channels [100 V/0.6 A]; CH1: I_{LED} (0.5 A / div), CH2: V_{LED} (50 V / div), CH3: $V_{GATE-QL802}$ (5 V / div), Time Scale: 100 ms / div.

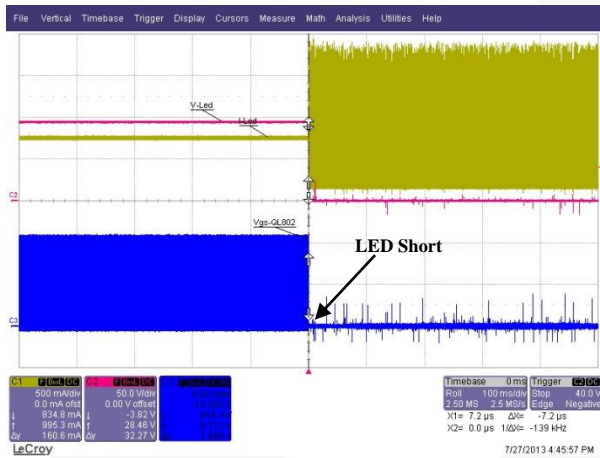

Figure 71. LED Short

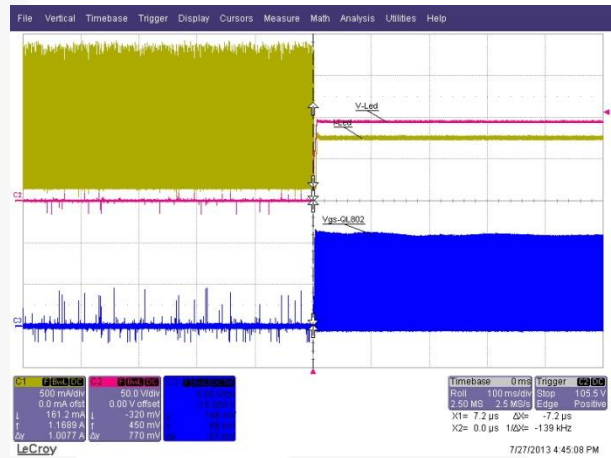

Figure 72. Recover from LED Short

Figure 73 and Figure 74 show waveforms for output voltage and current when an LED is opened and recovered in one of the LED channels [100 V/0.6 A]; CH1: I_{LED} (0.5 A / div), CH2: V_{LED} (50 V / div), CH3: $V_{GATE-QL802}$ (5 V / div), Time Scale: 100 ms / div.



Figure 73. LED Open

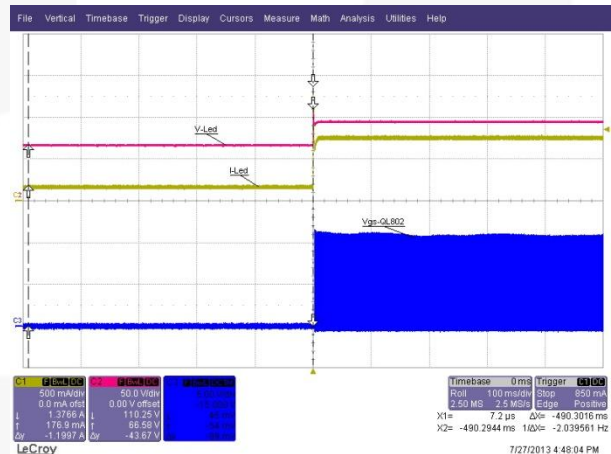

Figure 74. Recover from LED Open

8.15. Operating Temperature

Figure 75 shows temperatures measured for the primary and secondary active components in the top side at 85 V_{AC} line voltage and rated output load [two LED channels: 100 V/1.2 A].

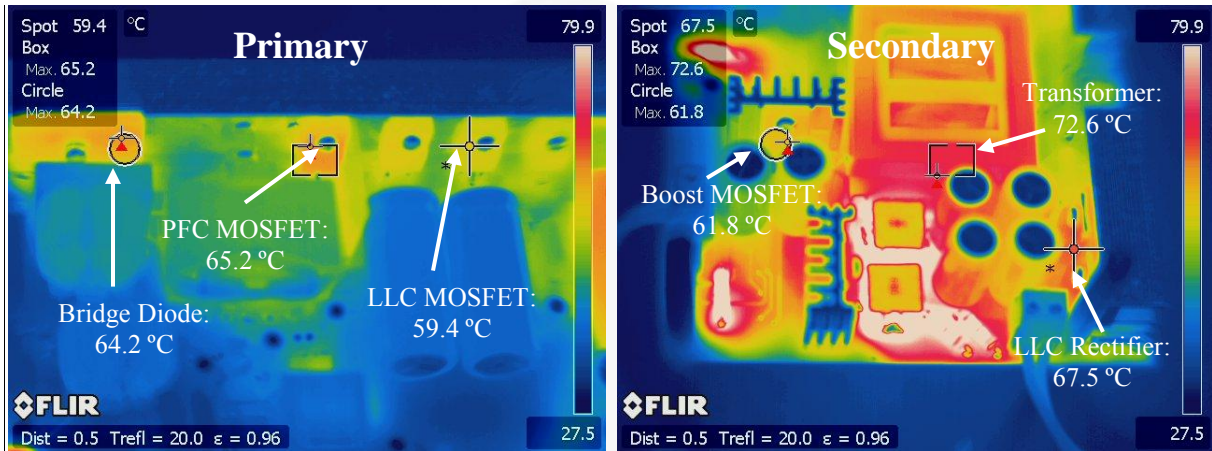

Figure 75. Board Temperature - V_{IN}[85 V_{AC}]

Figure 76 shows temperatures measured for the primary [top] and secondary [bottom] active components at 300 V_{AC} line voltage and rated output load [two LED channels: 100 V/1.2 A].

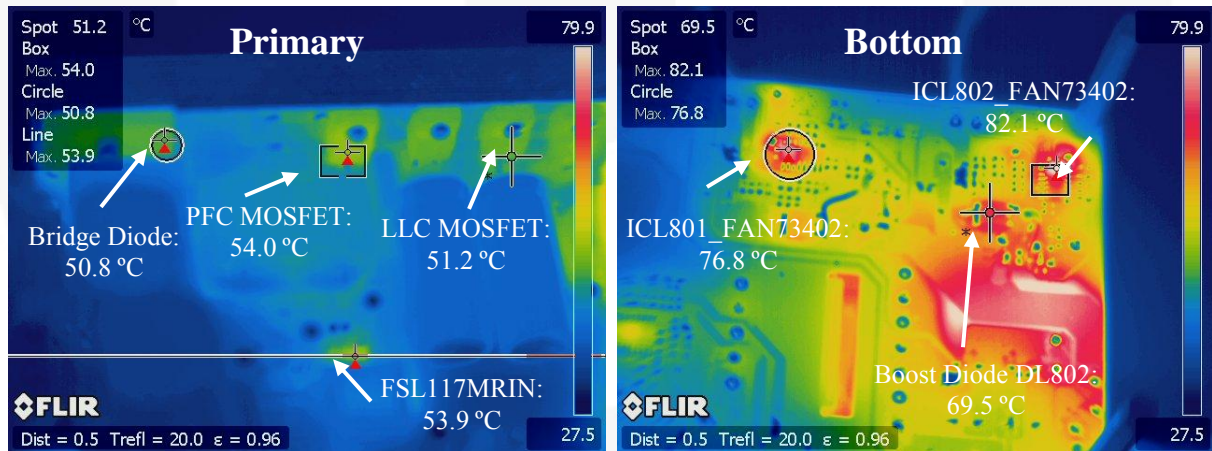

Figure 76. Board Temperature - V_{IN}[300 V_{AC}]

Note: The FAN73402 temperature can be reduced by changing PCB layout.

9. Revision History

Rev.	Date	Description
1.0.0	July, 2013	Initial Release

WARNING AND DISCLAIMER

Replace components on the Evaluation Board only with those parts shown on the parts list (or Bill of Materials) in the Users' Guide. Contact an authorized Fairchild representative with any questions.

The Evaluation board (or kit) is for demonstration purposes only and neither the Board nor this User's Guide constitute a sales contract or create any kind of warranty, whether express or implied, as to the applications or products involved. Fairchild warrants that its products meet Fairchild's published specifications, but does not guarantee that its products work in any specific application. Fairchild reserves the right to make changes without notice to any products described herein to improve reliability, function, or design. Either the applicable sales contract signed by Fairchild and Buyer or, if no contract exists, Fairchild's standard Terms and Conditions on the back of Fairchild invoices, govern the terms of sale of the products described herein.

DISCLAIMER

FAIRCHILD SEMICONDUCTOR RESERVES THE RIGHT TO MAKE CHANGES WITHOUT FURTHER NOTICE TO ANY PRODUCTS HEREIN TO IMPROVE RELIABILITY, FUNCTION, OR DESIGN. FAIRCHILD DOES NOT ASSUME ANY LIABILITY ARISING OUT OF THE APPLICATION OR USE OF ANY PRODUCT OR CIRCUIT DESCRIBED HEREIN; NEITHER DOES IT CONVEY ANY LICENSE UNDER ITS PATENT RIGHTS, NOR THE RIGHTS OF OTHERS.

LIFE SUPPORT POLICY

FAIRCHILD'S PRODUCTS ARE NOT AUTHORIZED FOR USE AS CRITICAL COMPONENTS IN LIFE SUPPORT DEVICES OR SYSTEMS WITHOUT THE EXPRESS WRITTEN APPROVAL OF THE PRESIDENT OF FAIRCHILD SEMICONDUCTOR CORPORATION.

As used herein:

1. Life support devices or systems are devices or systems which, (a) are intended for surgical implant into the body, or (b) support or sustain life, or (c) whose failure to perform when properly used in accordance with instructions for use provided in the labeling, can be reasonably expected to result in significant injury to the user.
2. A critical component is any component of a life support device or system whose failure to perform can be reasonably expected to cause the failure of the life support device or system, or to affect its safety or effectiveness.

ANTI-COUNTERFEITING POLICY

Fairchild Semiconductor Corporation's Anti-Counterfeiting Policy. Fairchild's Anti-Counterfeiting Policy is also stated on our external website, www.fairchildsemi.com, under Sales Support.

Counterfeiting of semiconductor parts is a growing problem in the industry. All manufacturers of semiconductor products are experiencing counterfeiting of their parts. Customers who inadvertently purchase counterfeit parts experience many problems such as loss of brand reputation, substandard performance, failed applications, and increased cost of production and manufacturing delays. Fairchild is taking strong measures to protect ourselves and our customers from the proliferation of counterfeit parts. Fairchild strongly encourages customers to purchase Fairchild parts either directly from Fairchild or from Authorized Fairchild Distributors who are listed by country on our web page cited above. Products customers buy either from Fairchild directly or from Authorized Fairchild Distributors are genuine parts, have full traceability, meet Fairchild's quality standards for handling and storage and provide access to Fairchild's full range of up-to-date technical and product information. Fairchild and our Authorized Distributors will stand behind all warranties and will appropriately address any warranty issues that may arise. Fairchild will not provide any warranty coverage or other assistance for parts bought from Unauthorized Sources. Fairchild is committed to combat this global problem and encourage our customers to do their part in stopping this practice by buying direct or from authorized distributors.

ON Semiconductor and  are trademarks of Semiconductor Components Industries, LLC dba ON Semiconductor or its subsidiaries in the United States and/or other countries. ON Semiconductor owns the rights to a number of patents, trademarks, copyrights, trade secrets, and other intellectual property. A listing of ON Semiconductor's product/patent coverage may be accessed at www.onsemi.com/site/pdf/Patent-Marking.pdf. ON Semiconductor reserves the right to make changes without further notice to any products herein. ON Semiconductor makes no warranty, representation or guarantee regarding the suitability of its products for any particular purpose, nor does ON Semiconductor assume any liability arising out of the application or use of any product or circuit, and specifically disclaims any and all liability, including without limitation special, consequential or incidental damages. Buyer is responsible for its products and applications using ON Semiconductor products, including compliance with all laws, regulations and safety requirements or standards, regardless of any support or applications information provided by ON Semiconductor. "Typical" parameters which may be provided in ON Semiconductor data sheets and/or specifications can and do vary in different applications and actual performance may vary over time. All operating parameters, including "Typicals" must be validated for each customer application by customer's technical experts. ON Semiconductor does not convey any license under its patent rights nor the rights of others. ON Semiconductor products are not designed, intended, or authorized for use as a critical component in life support systems or any FDA Class 3 medical devices or medical devices with a same or similar classification in a foreign jurisdiction or any devices intended for implantation in the human body. Should Buyer purchase or use ON Semiconductor products for any such unintended or unauthorized application, Buyer shall indemnify and hold ON Semiconductor and its officers, employees, subsidiaries, affiliates, and distributors harmless against all claims, costs, damages, and expenses, and reasonable attorney fees arising out of, directly or indirectly, any claim of personal injury or death associated with such unintended or unauthorized use, even if such claim alleges that ON Semiconductor was negligent regarding the design or manufacture of the part. ON Semiconductor is an Equal Opportunity/Affirmative Action Employer. This literature is subject to all applicable copyright laws and is not for resale in any manner.

PUBLICATION ORDERING INFORMATION

LITERATURE FULFILLMENT:

Literature Distribution Center for ON Semiconductor
19521 E. 32nd Pkwy, Aurora, Colorado 80011 USA
Phone: 303-675-2175 or 800-344-3860 Toll Free USA/Canada
Fax: 303-675-2176 or 800-344-3867 Toll Free USA/Canada
Email: orderlit@onsemi.com

N. American Technical Support: 800-282-9855 Toll Free
USA/Canada
Europe, Middle East and Africa Technical Support:
Phone: 421 33 790 2910
Japan Customer Focus Center
Phone: 81-3-5817-1050

ON Semiconductor Website: www.onsemi.com
Order Literature: <http://www.onsemi.com/orderlit>
For additional information, please contact your local
Sales Representative